

Gas Built in Hob(LPG / TG)

RB-782S
RB-782G
RB-783G

RB-982G
RB-983S
RB-983G

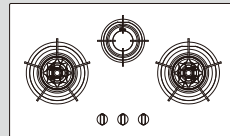
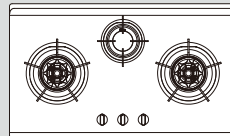
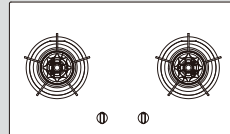
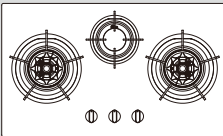
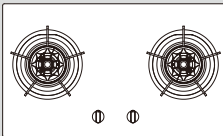
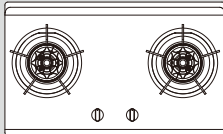

Gas Built in Hob Instruction / Installation Manual

Rinnai

Contents

Guide to Appliances RB-782S / RB-782G / RB-783G / RB-982G / RB-983S / RB-983G	1
Specification	3
Safety Instructions	5
Using for the first time	7
Installation Guide	8
Operation	13
Suitable Pans	15
Cleaning and Care	16
Trouble Shooting Guide	19



IMPORTANT

To register your product warranty, please paste the serial numbers stickers enclosed with the packaging on your warranty card. Please contact your local Rinnai Customer Care Centre should you require further assistance.

Guide to the Appliances

RB-782S

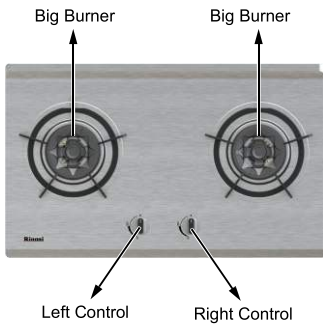

RB-782G

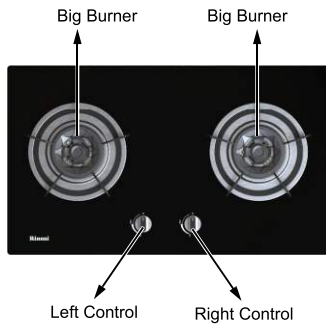

RB-783G

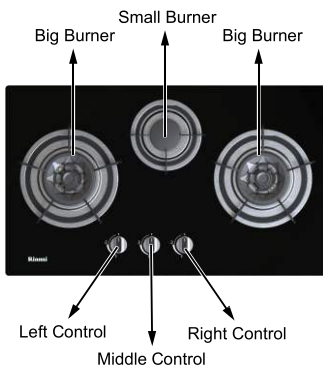

RB-982G

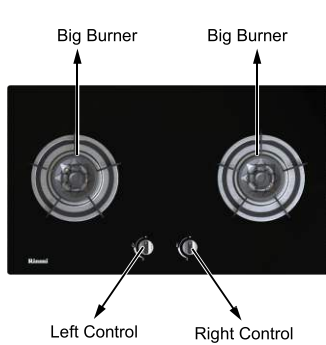

RB-983S

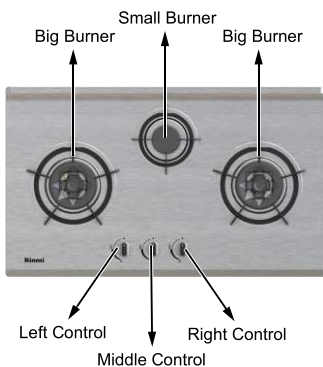

RB-983G

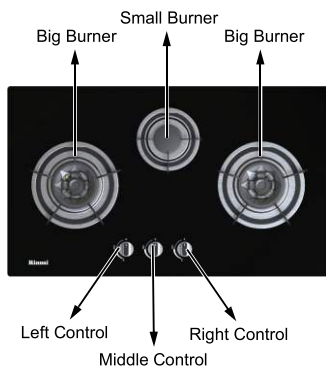

Guide to the Appliances

Burner Assembly

Small Burner

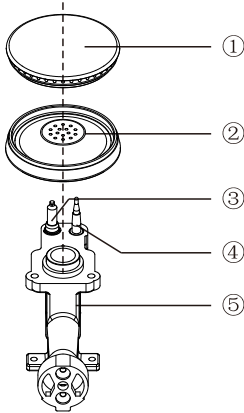

- 1 Burner Cap
- 2 Burner Body
- 3 Ignition Plug
- 4 Thermocouple
- 5 Ventury

Big Burner

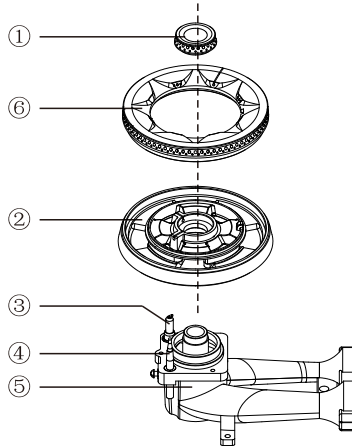

- 1 Simmer Cap
- 2 Burner Body
- 3 Ignition Plug
- 4 Thermocouple
- 5 Ventury
- 6 Burner Head

Safety Cut Off System

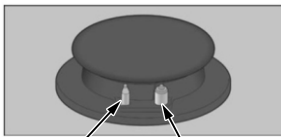

Thermocouple

Ignition Plug



For illustration purpose only



Your hob is equipped with a safety device (thermocouple) that cuts off the gas when the burners are accidentally switched off.

To ensure that this device is active:



1. Switch on the burner as usual.
2. Without releasing the control knob, press and hold it down firmly for 5 seconds after lighting the flame.

Specification

					
Rinnai Model No.		RB-782S	RB-782G		
Cut-out Size(mm)		650~730×350~410 4-R120	650~730×350~410 4-R120		
Product Size(mm)		760×460×145	780×460×145		
Rating(kW) & Nozzle Injector Size (Ø) (mm)					
For Singapore	LPG 30 mbar	Left: 4.5kW	0.90 + 0.42	Left: 4.5kW	0.90 + 0.42
		Right: 4.5kW	0.90 + 0.42	Right: 4.5kW	0.90 + 0.42
	NIL		NIL	NIL	
	TG 10 mbar	Left: 4.2kW	2.5 + 1.2	Left: 4.2kW	2.5 + 1.2
Right: 4.2kW		2.5 + 1.2	Right: 4.2kW	2.5 + 1.2	
NIL		NIL		NIL	
For Malaysia	LPG 30 mbar	Left: 5.0kW	0.94 + 0.46	Left: 5.0kW	0.94 + 0.46
		Right: 5.0kW	0.94 + 0.46	Right: 5.0kW	0.94 + 0.46
		NIL		NIL	NIL
Top Plate		Stainless Steel		Tempered Glass	
Burners		Left: (B)		Left: (B)	
		Right: (B)		Right: (B)	
		NIL		NIL	
Pan Support		Cast Iron/Q235 (Matt Enamel)		Cast Iron/Q235 (Matt Enamel)	
Knob		Rotary Knob(Bake lite)		Rotary Knob(Bake lite)	
Flame Safety Device		Yes		Yes	
Ignition		(DC 1.5V) Battery D size		(DC 1.5V) Battery D size	

					
Rinnai Model No.		RB-783G	RB-982G		
Cut-out Size(mm)		650~730×350~410 4-R120	705~840×405~480 4-R120		
Product Size(mm)		780×460×145	880×520×145		
Rating(kW) & Nozzle Injector Size (Ø) (mm)					
For Singapore	LPG 30 mbar	Left: 4.5kW	0.90 + 0.42	Left: 4.5kW	0.90 + 0.42
		Right: 4.5kW	0.90 + 0.42	Right: 4.5kW	0.90 + 0.42
	Center:2.0kW		0.68	NIL	
	TG 10 mbar	Left: 4.2kW	2.5 + 1.2	Left: 4.2kW	2.5 + 1.2
Right: 4.2kW		2.5 + 1.2	Right: 4.2kW	2.5 + 1.2	
Center:2.0kW		1.8		NIL	
For Malaysia	LPG 30 mbar	Left: 5.0kW	0.94 + 0.46	Left: 5.0kW	0.94 + 0.46
		Right: 5.0kW	0.94 + 0.46	Right: 5.0kW	0.94 + 0.46
		Center:2.0kW		0.68	
Top Plate		Tempered Glass		Tempered Glass	
Burners		Left: (B)		Left: (B)	
		Right: (B)		Right: (B)	
		Center: (S)		NIL	
Pan Support		Cast Iron/Q235 (Matt Enamel)		Cast Iron/Q235 (Matt Enamel)	
Knob		Rotary Knob(Bake lite)		Rotary Knob(Bake lite)	
Flame Safety Device		Yes		Yes	
Ignition		(DC 1.5V) Battery D size		(DC 1.5V) Battery D size	

Specification

					
Rinnai Model No.		RB-983S		RB-983G	
Cut-out Size(mm)		705-840×405-480 4-R120		705-840×405-480 4-R120	
Product Size(mm)		880×520×145		880×520×145	
Rating(kW) & Nozzle Injector Size (Ø) (mm)					
For Singapore	LPG 30 mbar	Left: 4.5kW	0.90 + 0.42	Left: 4.5kW	0.90 + 0.42
		Right: 4.5kW	0.90 + 0.42	Right: 4.5kW	0.90 + 0.42
		Center:2.0kW	0.68	Center:2.0kW	0.68
	TG 10 mbar	Left: 4.2kW	2.5 + 1.2	Left: 4.2kW	2.5 + 1.2
		Right: 4.2kW	2.5 + 1.2	Right: 4.2kW	2.5 + 1.2
		Center:2.0kW	1.8	Center:2.0kW	1.8
For Malaysia	LPG 30 mbar	Left: 5.0kW	0.94 + 0.46	Left: 5.0kW	0.94 + 0.46
		Right: 5.0kW	0.94 + 0.46	Right: 5.0kW	0.94 + 0.46
		Center:2.0kW	0.68	Center:2.0kW	0.68
Top Plate		Stainless Steel		Tempered Glass	
Burners		Left: (B)		Left: (B)	
		Right: (B)		Right: (B)	
		Center:(S)		Center:(S)	
Pan Support		Cast Iron/Q235 (Matt Enamel)		Cast Iron/Q235 (Matt Enamel)	
Knob		Rotary Knob(Bake lite)		Rotary Knob(Bake lite)	
Flame Safety Device		Yes		Yes	
Ignition		(DC 1.5V) Battery D size		(DC 1.5V) Battery D size	

Safety Instructions

To avoid the risk of accidents and damage to the appliance, please read these instructions carefully before installation and using it for the first time. They contain important notes on installation, safety, operation and care.

Keep this manual in a safe place and ensure that new users are familiar with the instructions. Pass them on to any future owner.

Safety Precautions

- All operations including installations, repairs, maintenance, gas and electrical connection or conversion to other types of gas must be carried out by a suitably qualified and competent person as set out by the local gas and electricity providers. You are to contact your local Rinnai Customer Care Centres if there is a need to convert to another type of gas.
- Using the gas hob will cause a build-up of heat and moisture in the room in which it is installed. Ensure that the room has sufficient natural or mechanical means of ventilation, e.g. an extractor.
- If the hob is used for very long periods of time additional ventilation of the room may be necessary, e.g. by opening windows or doors, or running the extractor on the highest setting.
- This gas hob is not designed for commercial or professional use. It is only intended for use in domestic households. Any other usage of the appliance other than the purpose in which it is designed for could void the warranty. The manufacturer is exempt from all responsibilities resulting from incorrect or improper use or operation.
- This appliance is not intended for use by people with reduced physical, sensory or mental capabilities, or lack of experience and knowledge, unless they are supervised whilst using it, or have been shown how to use it by a person responsible for their safety.
- This appliance leaves the factory set to the type of gas that is indicated on the specifications plate. If this must be changed, call your local Rinnai Customer Care Centres.
- Never open the outer casing of the appliance. Tampering with electrical connections or components and mechanical parts is highly dangerous to the user and can cause operational faults
- The surfaces of cooking appliances heat up during use. Care must be taken when using these appliances. Keep children well away from this appliance.
- Fats or oil which is overheated can catch fire easily. Do not leave oil or fats to heat up unattended. If oil or fats do catch fire, never use water to put the fire out. Put the fire out by covering the pan with a lid and switch off the appliance.
- Do not store or use corrosive chemicals, steamers, flammable materials or non-food products below or near this domestic appliance.
- If the appliance has not been used for a long period of time it should be thoroughly cleaned before it is used again. It is also advisable to have the appliance tested for safety

Safety Instructions

- If a cooker hood is installed above the gas hob, ensure that the burners are always covered with a pan when in use. Otherwise flames could reach the cooker hood, parts of which could then be damaged or set on fire.
- Do not cover the appliance, e.g. with a cloth, kitchen foil, etc. This could be a fire hazard if residual heat is still present or the appliance is switched on by mistake.
- Do not use plastic or aluminium foil containers. These melt at high temperatures and could catch fire
- Do not heat up unopened tins of food on the hob as pressure will build up in the tin, causing it to explode. This could result in injury and scalding or damage.
- Make sure all the components of the gas burners have been correctly assembled before switching on.
- Pans must be of the correct size for the burner's they are used on (see "Suitable pans"). A pan which is too small will be unstable on the pan support. If the pan diameter is too large, flames can spread out to the sides and damage or burn the worktop, wall claddings or surrounding units and also parts of the hob.
- Connection to the gas supply must be carried out by a suitably qualified and competent person in strict accordance with current local safety regulations
- For safety reasons, this appliance may only be used when it has been built in.
- Installation, maintenance and repairs may only be carried out by a suitably qualified and competent person in strict accordance with current local safety regulations.
- During installation, maintenance and repair work, the appliance must be disconnected from the gas supply and mains electricity supply. While the appliance is under warranty, repairs should only be undertaken by a service technician authorised by Rinnai. Otherwise the guarantee is invalidated
- Faulty components must only be replaced with genuine original spare parts. The manufacturer can only guarantee the safety of the appliance when original replacement parts are used.
- Never leave the appliance unattended during operation. The graphics in this instruction manual are given as a guide only.

The Manufacturer cannot be held liable for any damages caused by non-compliance with these Warning and Safety Instructions.

Using for the first time

- Remove any protective foil and adhesive labels.
- Clean all removable parts of the burners with a solution of warm water and a little washing-up liquid applied with a soft sponge. Dry all parts thoroughly after cleaning and then reassemble the burners (see "Cleaning and care").
- Clean the stainless steel trough with a damp cloth, and then wipe dry.

The metal components have a protective coating which may give off a slight smell when heated up for the first time.

The smell and any vapours will dissipate after a short time, and do not indicate a faulty connection or appliance.

Caution for Glass Top Hobs

- Do not place anything, e.g. flame tamer or asbestos mat, between pan and pan support, as serious damage to the appliance may result.

NOTE The enclosure may be circular or square.



- Do not remove the pan support and enclose the burner with a wok stand, as this will concentrate and deflect heat onto the hotplate.

NOTE The enclosure may be circular or square.



- Do not use large pots or heavy weights that can bend the pan support or deflect flame onto the hotplate.

NOTE The enclosure may be circular or square.



- Locate pan centrally over the burner so that it is stable and does not overhang the appliance.

NOTE The enclosure may be circular or square.



- Use only a wok support supplied or recommended by the manufacturer of the appliance.

NOTE The enclosure may be circular or square.



Installation

All operations relating to installations, regulations and conversions to other types of gas must be carried out by an authorised installation personnel, respecting applicable regulations, standards and the specifications of the gas and electricity providers.

Before you begin, turn off the appliance's electricity and gas supply.

You are recommended to contact your local Rinnai Customer Care Centres to convert to another type of gas.

The units next to the appliance must be made of non-flammable materials. The laminated covering and glue for adhering it must be heat resistant.

This appliance cannot be installed above fridges, washing machine and dish washer or similar.

An oven must have a power cooling fan to install a hob above it. Check the oven's dimensions in its installation manual.

If a cooker hood is installed, you must follow the installation manual's instructions, always keeping a minimum distance of 627 mm to the hob.

Preparing the Bench Top (Fig 2 & Fig 3)

Make an appropriate size cut in the work surface.

It is recommendable to place a non-flammable separator (e.g. metal or plywood) 10 mm from the bottom of the hob. This will prevent access to the base of the hob.

On wood surfaces, varnish the cutting surfaces with a special glue. This protects them from moisture which could collect under the work surface.

Installation of Appliance

The adhesive seal (underside of the hob) are factory-fitted: do not under any circumstances remove them. The seal ensures that the entire work surface will be watertight and prevents water seepage.

In order to fit the appliance into the kitchen unit, first place the hob in the correct position. Insert and centre the hob. Press the sides of the hob until it is supported around its entire perimeter.

No conversion to different gases of another family is recommended, this appliance shall use the gas of the family that it is designed for and adjusted at factory.

Removal of Hob (Fig 1)

- 1) Turn off incoming gas
- 2) Remove gas hose
- 3) Lift the hob up.

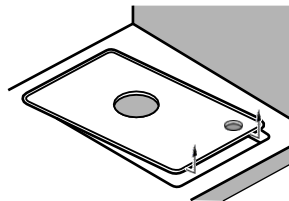
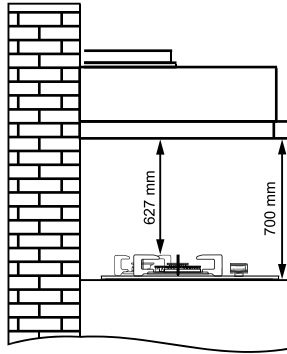
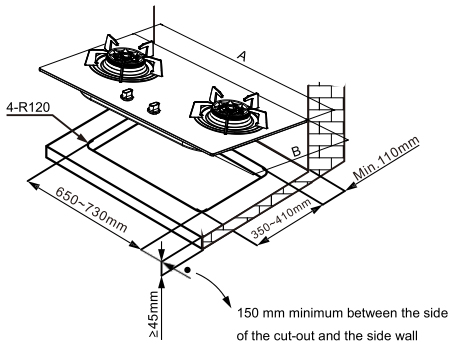

Fig 1

Fig 2 & Fig 3



RB-782S & RB-782G & RB-783G



Model	Product Size (mm)	
	A	B
RB-782S	760	460
RB-782G	780	460
RB-783G	780	460

RB-983S & RB-983G & RB-982G

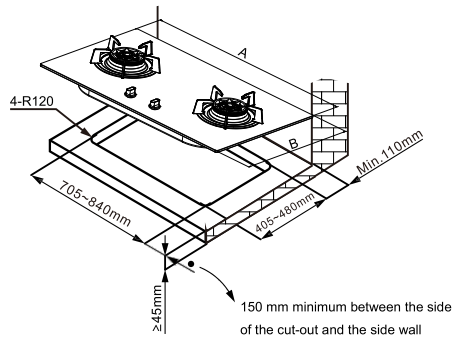

Model	Product Size (mm)	
	A	B
RB-982G	880	520
RB-983S	880	520
RB-983G	880	520

- 1) Front
- 2) Battery Holder
- 3) Gas inlet

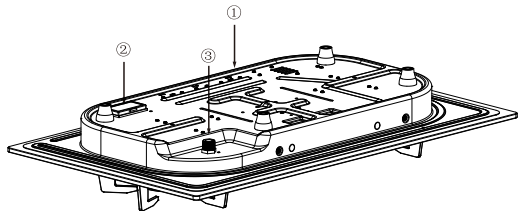

Securing the Bottom Casing on to the Bench

Secure the bottom casing on to the bench by fixing the 4 screws provided, 2 screws in the front and 2 screws at the rear of the bottom casing (refer to the pictogram and instructions below) if necessary to prevent the hob from wobbling during usage
RB-983G/RB-982G adjustable range: 705-840 × 405-480(mm)
RB-782G adjustable range: 650-730 × 350-410(mm)

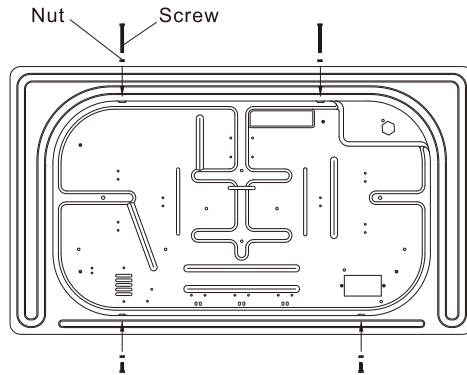

- ① Place the adjustable screw at the position indicated by the arrow on the bottom shell.

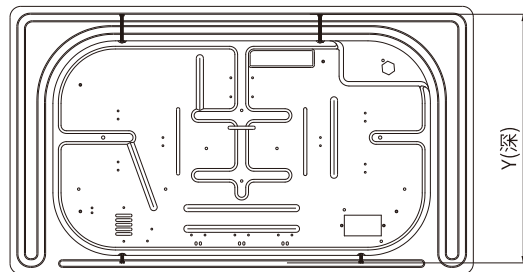

- ② Screw to adjust the size of the corresponding y depth according to the actual opening size, and fix it with nuts

Electrical installation

Please install a DC 1.5v battery into the battery casing at the bottom of the Hob. (Fig 4)

When the battery is exhausted or the spark has become weak, a new battery should be replaced. The battery compartment is located as shown in the diagram. Place the battery in the correct polarity as shown.

Warning: Please take out the battery if the hob is not use for a long time.

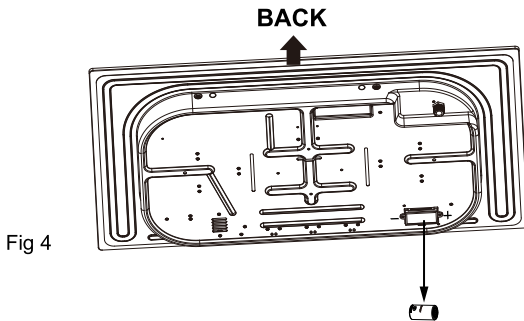

Fig 4

Gas Connection (Fig. 5)

The end of the inlet connection point of the gas hob has a 1/2" thread that allows for:

- Fixed connection.
- Connection using a flexible hose (For LPG only). In this case, it is necessary to insert the accessory and the O-Ring as shown in Fig. 5. In this case, you must prevent the pipe from coming into contact with moving parts of the kitchen unit being inserted (for example, a drawer) and prevent access to any spaces which might become obstructed.

Warning! If any connection is handled, check for gas leakage. The manufacturer is not liable for any connection leak.

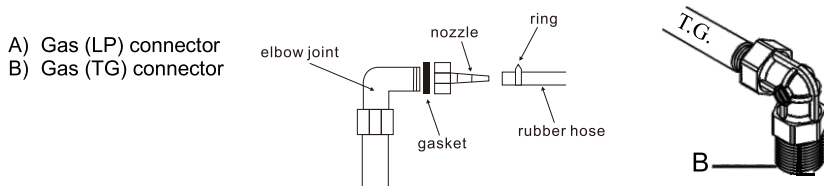

- A) Gas (LP) connector
- B) Gas (TG) connector

Fig 5

Electrical Connection

Fig 6 & Fig 7

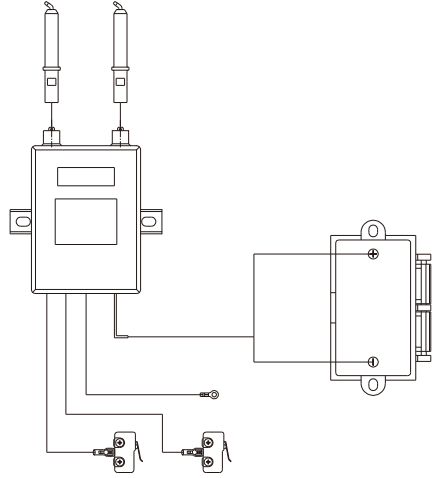

Fig 6

RB-782S / RB-782G / RB-982G

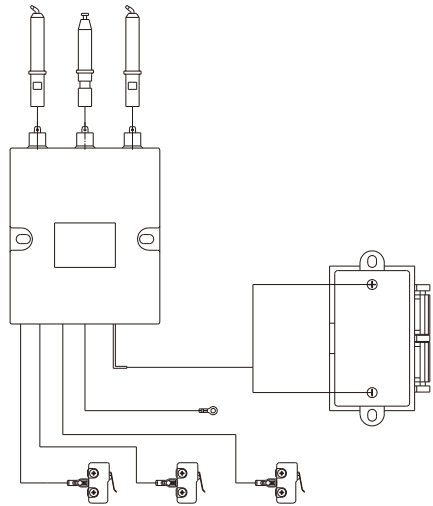
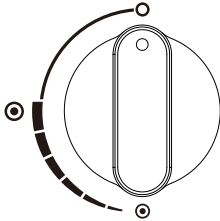

Fig 7

RB-783G / RB-983S / RB-983G

Control Knob

- The control knob is used to ignite the burner and to regulate the strength of the flame.



- The gas supply is turned off
- Max Flame
- Min Flame

The burners can only be operated by pressing down the appropriate control knob and turning it anti-clockwise and switched off by turning the control knob clockwise.

**The following will cause damage to the appliance:
Operating the burner without pressing the control down,
Operating the burner on by turning the control clockwise,**

The manufacturer will not accept liability for any damage resulting from incorrect operation.

Operating

- The control knob for the burner required must be pressed down and turned anti-clockwise to the large flame symbol in order to operate.

Pressing a burner control knob will automatically create a spark on all burners. This is normal and no cause for concern

- When the flame ignites, hold the control knob down for 5 seconds and let go.
- The ignition device should not be operated for more than 15 seconds. If after 15 seconds, the burner still did not lit up, please release the control knob and do not operate again. Do wait for at least a few minutes before trying again.
- If the flame goes out, turn the control back to "○". Wait for at least 1 minute before attempting to re-ignite it, press down and hold the control for longer if required
- If the burner fails to ignite for the second time, turn the control back to "○". Refer to the troubleshooting guide for more information.

Regulating the Flame

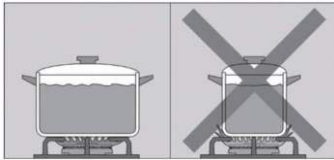

The burners can be regulated at any level between the highest and lowest flame.

Control the flame so that it does not spread out beyond the sides of the pan. As the outer part of the flame is much hotter than the centre, the tips of the flames should stay beneath the pan base. Flame tips which extend beyond the sides of the pan merely warm up the air in the room and can also damage pan handles and increase the danger of injury

Switching OFF

Turn the control clockwise to position "O"

This stops the flow of gas and the flame goes out

Warnings

- It is normal to hear a slight whistling noise while the burner is operating.
- When it is first used for the first time, it is normal for the burner to give off odours; this does not pose any risk and does not indicate a malfunction; the smell will be gone over time.
- A few seconds after the burner is switched off, a sound (thud) will be produced. This is not a fault - this means that the safety device is no longer operating.
- Keep the burner as clean as possible. If the ignition plug are dirty they will not light properly. Clean them periodically using a small non-wire brush. Bear in mind that the ignition plug must not suffer any serious impacts.
- An orange-coloured flame is normal. This is caused by the presence of dust in the atmosphere, spill liquids, etc.
- The kitchen will become hot and humid when this gas appliance is used. You must therefore ensure that the kitchen is well ventilated: either keeping the natural ventilation apertures open or install a ventilation system (cooker hood).
- If using the appliance intensively for prolonged periods, you may require additional ventilation (e.g. by opening a window) or more effective ventilation (e.g. by increasing the hob's ventilation, if possible).
- If the burner flames are accidentally blown out, switch off the burner operating control knob and do not try to relight it for at least one minute.

Do not place any foreign objects including flame tamer, asbestos mat, wire guards etc between pan and pan support as serious damage to the appliance may occur.

The Manufacturer cannot be held liable for any damages or warranty claim caused by any non-compliance.

Suitable Pans

Suitable Pans (For the use of flat bottom pan only)



Burner	Minimum pan diameter (cm)	Maximum pan diameter (cm)
Big Burner	Ø 12 (When using pans below 12cm please use the pan adapter provided)	Ø 30
Small Burner	Ø 10	Ø 20

- Refer to the chart above and ensure that the pan diameter falls within the minimum and maximum diameters given for the burner you are using. A pan which is too small will be unstable on the pan support. If the pan base diameter is too large, flames can spread out to the sides and damage or burn the worktop, wall claddings or surrounding units and also parts of the hob. The manufacturer cannot be held liable for this type of damage.
- Select pans which are suitable for the burner they are to be used on. In general: use larger diameter pans on the large burners, and smaller diameter pans on the small burners
- Pans with thick bases are preferable as these distribute heat more evenly. With thin bases, there is a danger of food overheating in places. Stir the food frequently.
- Any heat-resistant pans can be used on a gas burner.

When placing pans on the pan support(s) make sure you position them so that they cannot tip up. Please note that it is not possible to prevent pans from wobbling very slightly.
Always place pans on the pan support(s) supplied. Pans must not be placed directly on the burner.

Cleaning and Care

- The appliance should be cleaned after each use. Allow the appliance to cool down to a safe temperature before cleaning.
- To avoid water marks and lime scale deposits, use a soft cloth to dry surfaces that have been cleaned with water.
- Stubborn soiling should be soaked first.
- Food which boils over onto the hot hob can cause the burner components and the stainless steel surface of the hob to discolour and can also cause damage or reduce lifetime of the parts. **Remove any soiling immediately.**
- The surfaces of the burner components will become more matt with time. This is quite normal and will not affect the operation of the hob.
- Clean all removable parts of the burners with a solution of warm water and a little washing-up liquid applied with a soft sponge. Dry all parts thoroughly after cleaning and then reassemble the burners (see " To Assemble the Big Burner & To Assemble the Small Burner).
- Clean the stainless steel trough with a damp cloth, and then wipe dry.

To avoid damaging the surface of your appliance, do not use:

- cleaning agents containing descaling agents, soda, alkaline, ammonia, acids or chlorides
- stain or rust removers
- abrasive cleaning agents, e.g. powder cleaners and cream cleaners
- solvent-based cleaning agents
- dishwasher cleaner

Cleaning of Glass Surface

Once the appliance is cool, clean the surface using a soft sponge with soap and water. Dry with a soft and dry cloth.



Warning! Do not use knives, scrapers or similar instruments to clean the surface of the glass or between the rims of the burners and the frame (if applicable).



Warning - Risk of injury!

Cracks or fractures on the glass plate are dangerous. Immediately shut off all burners.

Shut off the gas supply and do not touch the hob surface.

Contact your local Rinnai Customer Care Center.

Sudden changes in temperature may cause the breakage of the glass. While using your hob do not spill any cold liquids on it.

PERIODIC MAINTENANCE

Call to your local Rinnai Service Center periodically to check the condition of the hob.

Cleaning and Care

Cleaning

	Cleaning	Instructions
Stainless Steel & Glass Surface	<p>Clean stainless steel & glass surfaces with a solution of warm water and a little washing-up liquid applied with a soft sponge.</p> <p>If necessary, you could use the scouring pad on the reverse of a washing-up sponge. Apply with an even pressure following the direction of the "grain".</p>	<p>Printed surfaces (Flame symbols)</p> <p>Remove any soiling which comes into contact with the printed flame symbols straight away. Soiling, particularly salty food or liquid and olive oil, can cause damage if left on the printed surfaces for a long time.</p> <p>Do not use stainless steel cleaning agents on the printed flame symbols. This would rub off the print.</p>
Pan supports	<p>Remove the pan supports. Clean the pan supports using a solution of warm water and a little washing-up liquid applied with a soft sponge.</p> <p>If necessary, you could use the scouring pad on the reverse of a washing-up sponge</p>	<p>Stubborn soiling should be soaked first. The pan supports are not dishwasher proof.</p>
Controls	<p>Clean the controls with a solution of warm water and a little washing-up liquid applied with a soft sponge.</p>	<p>The controls are not dishwasher proof.</p>
Burner caps, Burner Body	<p>Clean the burner caps with a solution of warm water and a little washing-up liquid applied with a soft sponge.</p> <p>If necessary, you could use the scouring pad on the reverse of a washing-up sponge.</p>	<p>The burner caps are not dishwasher proof.</p> <p>Make sure that the flame slits are completely dry after cleaning.</p>
Ignition plug, thermocouple	<p>The Ignition plug and thermocouple should be very carefully wiped clean using a dry cloth.</p>	<p>Do not let the ignition plug gets wet, it will not spark</p>

Important:

To keep your Built-in hob in good condition

1. Always clean the top plate / glass after use.
2. Clean the burner when dirt is found close to the flame pit.
3. Do periodic inspection once a year by contacting your local Rinnai Customer Care Center.

To Assemble the Big Burner

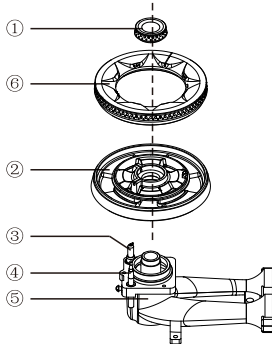

- Place burner body ② onto venturi ⑤. Ensure the burner body sits nicely on the venturi with the thermocouple ④ and the ignition plug ③ extend through their respective holes in the burner body.
- Position the burner head ⑥ onto the burner body ②.
- Position the simmer burner head ① onto the center of the burner body ②.

To Assemble the Small Burner

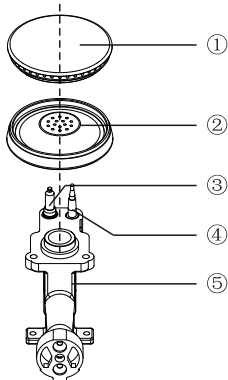

- Place the burner body ② onto the venturi ⑤ so that the thermocouple ④ and the ignition plug ③ fit into their respective slots along the burner body ②.
- Position the burner cap ① onto the burner base ②.

When correctly positioned it will not slide about.

Important: Replace parts in the correct order after cleaning.

Trouble shooting Guide

Fault	Possible cause	Solution
No ignition (DC)	<ul style="list-style-type: none"> • The battery have been used (drained) up. • Electrode gap excessive • Ignitor connections loose 	<ul style="list-style-type: none"> ➤ Replaced a new battery ➤ Check gap, and adjust. The gap should be around 4 to 5mm.
The automatic ignition function does not work	<ul style="list-style-type: none"> • Cleaning products stuck between the ignitor and the burners. • The burners are wet. • The burner covers are not correctly positioned. 	<ul style="list-style-type: none"> ➤ The space between the ignitor and the burner must be clean. ➤ Dry the burner covers carefully. ➤ Check that the covers are correctly positioned.
The burner flame is not uniform.	<ul style="list-style-type: none"> • The burner components are not correctly positioned. • The grooves on the burner cap & base are dirty. 	<ul style="list-style-type: none"> ➤ Ensure the components are correctly positioned. ➤ Clean the grooves on the burner cap & base. (depending on model)
The flow of gas does not appear normal or no gas comes out.	<ul style="list-style-type: none"> • The gas supply is blocked via intermediary valves. • If the gas is supplied from a gas cylinder, check that this is not empty. 	<ul style="list-style-type: none"> ➤ Open all intermediary valves. ➤ Change the gas cylinder.
The kitchen smells of gas.	<ul style="list-style-type: none"> • A gas tap has been left on. There may be a leak in the gas cylinder coupling. 	<ul style="list-style-type: none"> ➤ Turn off the gas taps. ➤ Check that the coupling is sound. ➤ Call your local Rinnai customer care centre if it is leaking from the hob.
The safety valves on one of the burners are not working.	<ul style="list-style-type: none"> • The control knob was not held down for long enough. • The grooves on the burner cap & base are dirty. 	<ul style="list-style-type: none"> ➤ Once the burner is lit, hold the control knob down a few seconds longer. ➤ Clean the grooves on the burner cap & base.

Rinnai

Model number: RB-XXX
 For: LP Gas Pressure: 3.0 kPa
 Input: X.XkW
 Serial no.:

This appliance shall be installed in accordance with the Regulation in force and only in a well ventilated space.
 Read the user's instructions manual before installing or using the appliance

If problem persists after the above check, please contact Rinnai Customer Care Centre for Assistance.

Please quote the model number of your appliance as shown on the rating plate attached to your equipment.

For service call under warranty, please note that it is necessary to produce your proof of purchase and valid warranty card.

Rating plate is for illustration purpose only and its specifications vary across models.