

Rinnai

GAS GRILL

RSB-923N / RSB-926N

Rinnai

ver. 090929

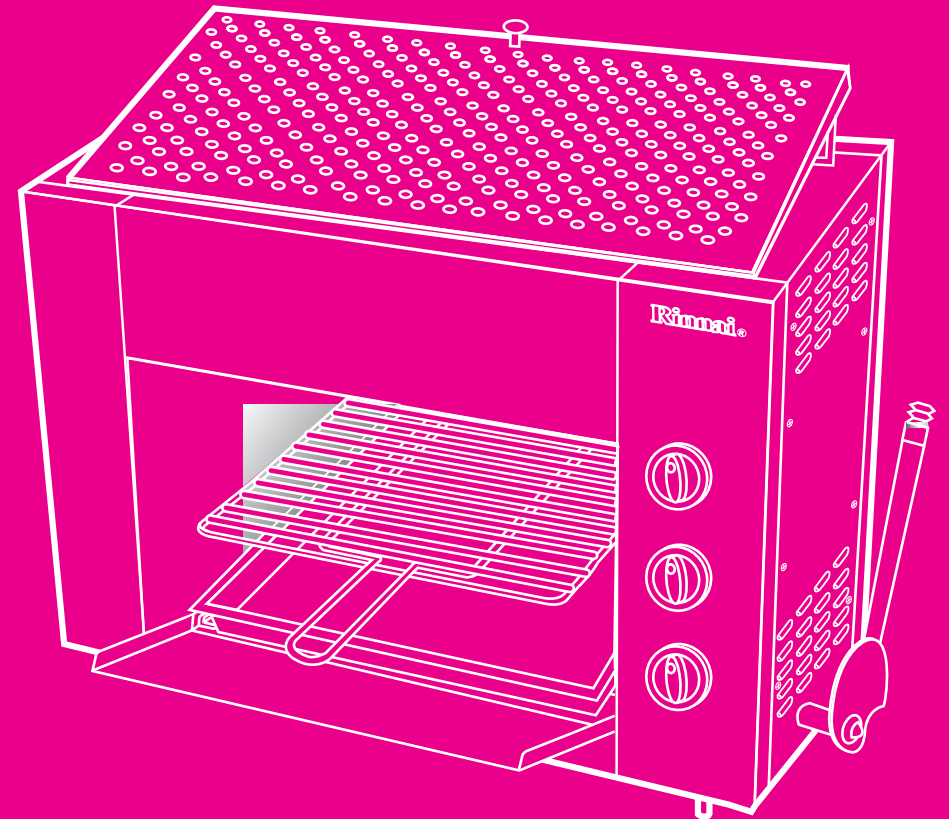

INDEX

Components	2
Product Installation	4
How to use	5
Exterior specifications	7

MEMO



Components

MEMO

Cover

Stand up the cover while using

Grill mesh lever button
Push the button when leveling

Knob

Oil or Soup tap

Insulate plate



Cover

Slide up the cover while a using

Knob

Oil or Soup

Insulation Plate

Grill mesh height leveling

Accessories

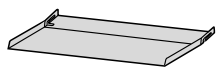

Insulation Plate
RSB-923N : 1PCS
RSB-926N : 1PCS

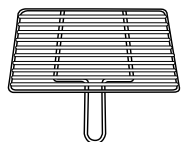

Grill Mesh
RSB-923N : 2PCS
RSB-926N : 4PCS



Oil & Soup Tray
RSB-923N : 1PCS
RSB-926N : 2PCS

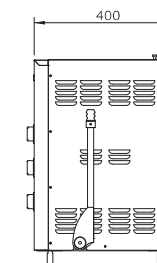
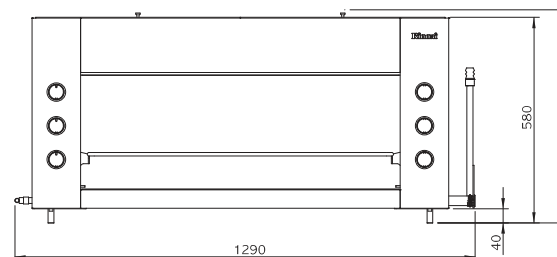
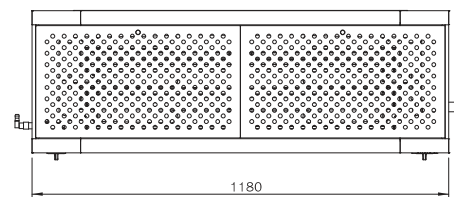

Description		Infra rayed gas griller
Model name		RSB-926N
Width (mm)		1260
Length (mm)		400
Height (mm)		600
Weight (kg)		42.4
Connection		φ 25mm
Consumption	LPG	14.0E-W(1.0kg/h)
	LNG	14.3E-W(1.300kg/h)

Product installation

Ventilation place

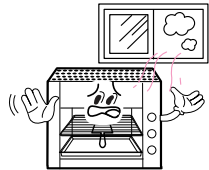

Short gas piping

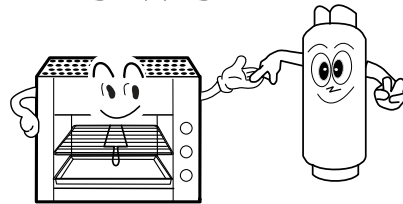

Away from flammable material

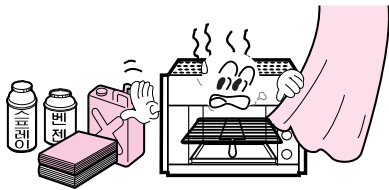

Keep clearance

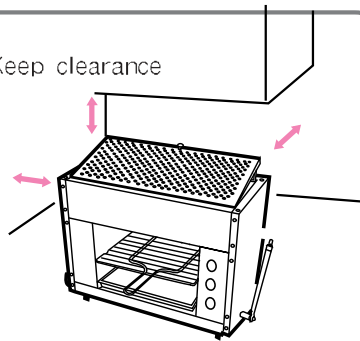

Stable & Even place

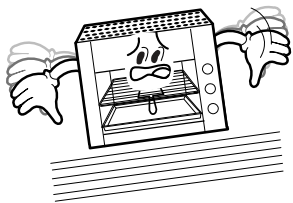

Fill up the water 2/3

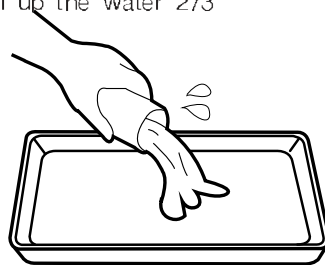

Exterior specifications

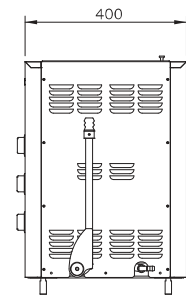
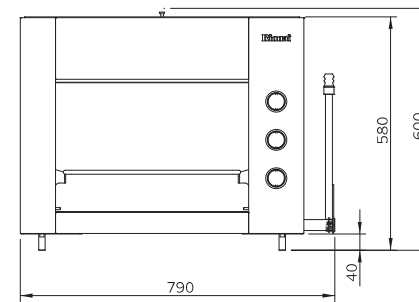
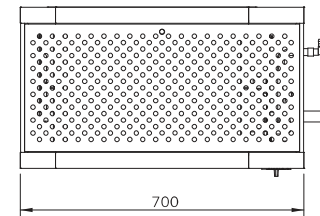

Description	Infra rayed gas grill	
Model name	DSB 223N	
Width (mm)	730	
Length (mm)	400	
Height (mm)	600	
Weight (kg)	26.3	
Connection	φ 3.5mm	
Consumption	LPG	7.12kW(0.51kg/h)
	LNG	7.21kW(6.200kgal/h)

How to use

- Open the intermediate valve

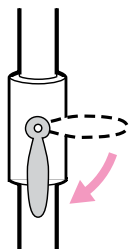

- Press the knob and turn to the "on" position (a clicking sound)

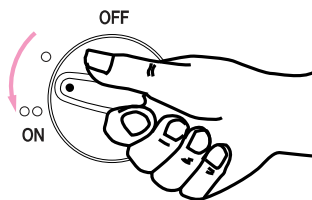

- After ignition, if the knob placed between "off" and "on" position
- The flame is weak condition.

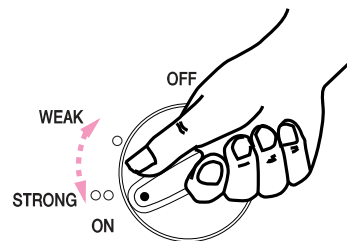

- Place the knob at ignition position and adjust a grill mesh height:
need "strong" fire : grill mesh supporter (upper position)
need "weak" fire : grill mesh supporter (upper position)

※ It is possible to control the flame power by ceramic burner number

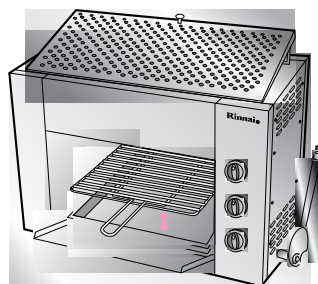

Extinguishment

- Turn the knob to the end of "off" position



- Close the gas intermediate valve

