



CREATING A HEALTHIER WAY OF LIVING
CATALOGUE 2025 VOL. 2



Rinnai

Rinnai

From Japan To The World
Creating A Healthier Way Of Living
Since 1920

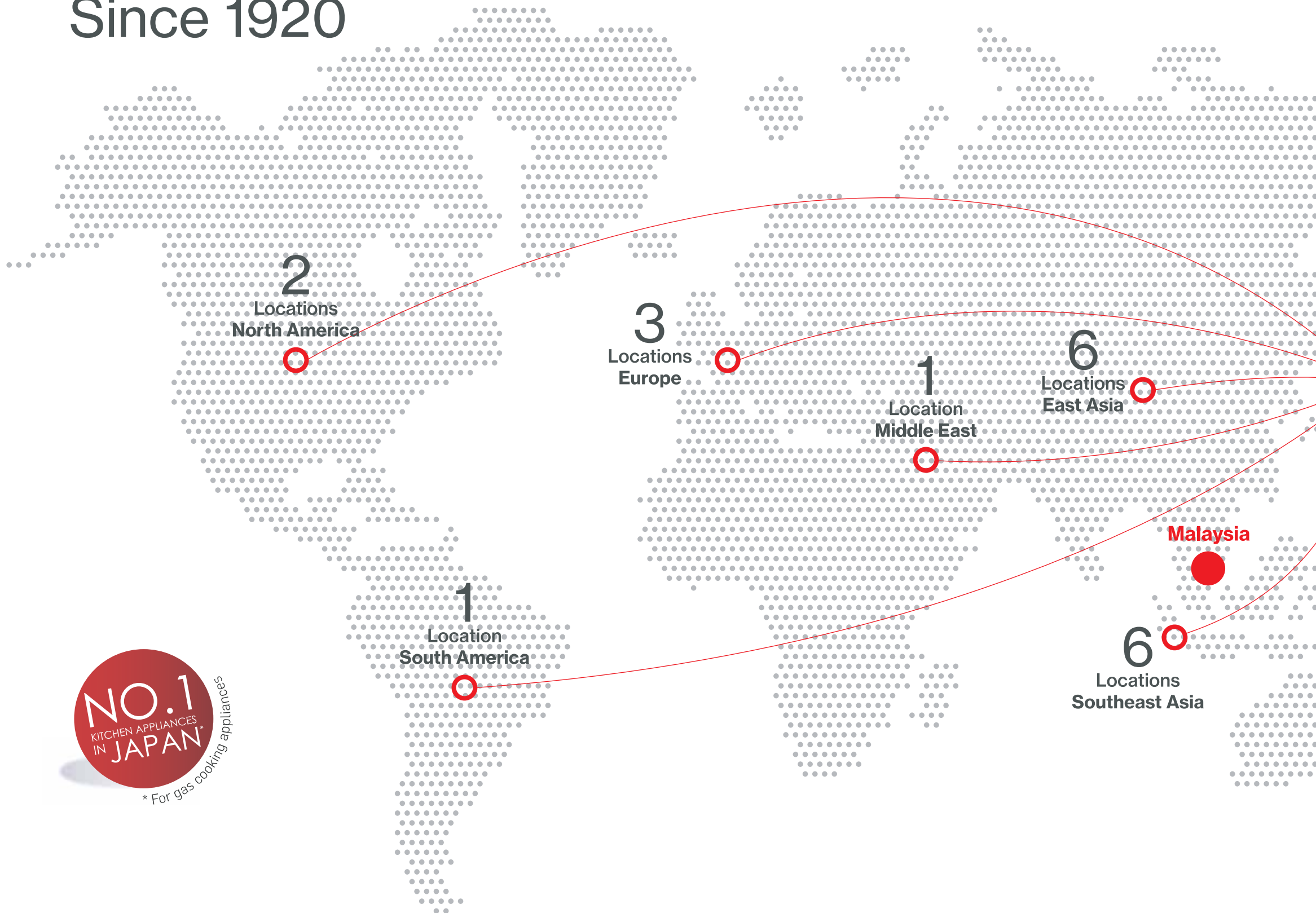

NO.1
KITCHEN APPLIANCES
IN JAPAN*
* For gas cooking appliances

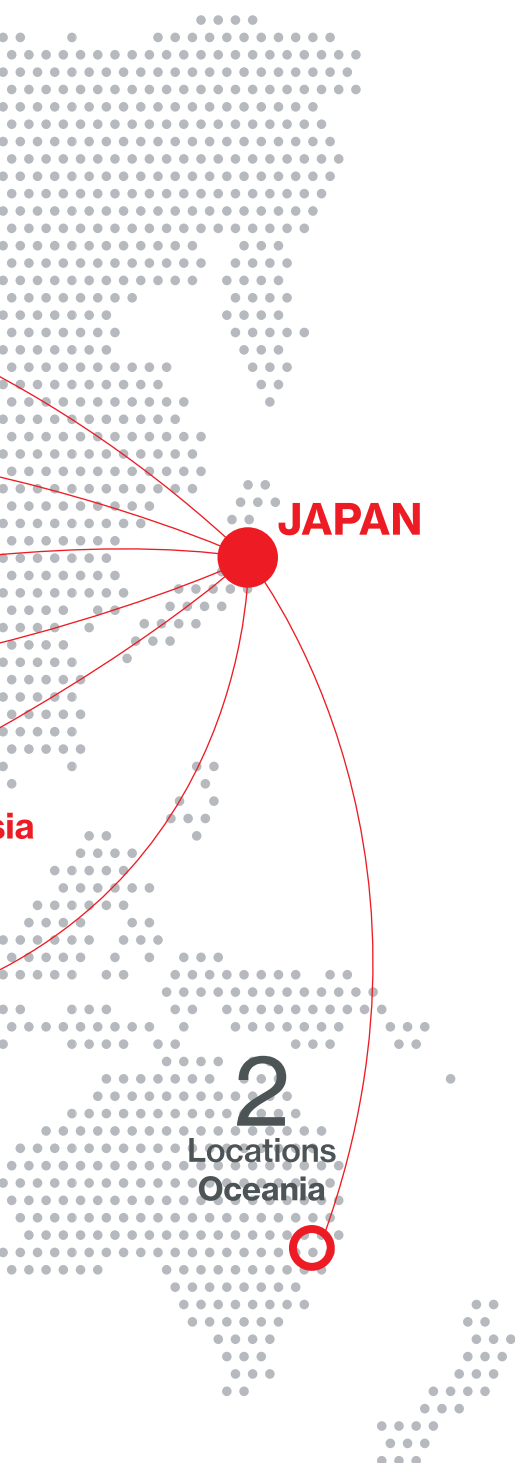

Built-in Hob

Inner Flame Series	03 - 04
Lotus Flame Series	05 - 06
Hyper Flame Series	07 - 08
Flexi Series	09 - 10
Economy Series	11 - 12
Electric Hob Series	13 - 16

Built-in Oven

Electric Oven Series	27 - 29
----------------------	---------

Gas Clothes Dryer

Laundry Series	31 - 32
----------------	---------

Electric Instant Water Heater

Aquarius Series	35
Sen Series	36

Promotion Package

Promotion Packages	39
--------------------	----

Cooker Hood

Plasma Series	17 - 18
Prestige Series	19 - 20
Elite Series	21 - 22
Designer Series	23 - 24
Chimney Series	25
Slim Series	26

Table Top Cooker with Grill

Howaro C Series	30
-----------------	----

Gas Water Heater

Water Heating System Series	33 - 34
-----------------------------	---------

Table Top Cooker

Heavy Cooking Series	37
Domestic Cooking Series	38

Technical Diagram

Products Technical Diagram	40 - 46
----------------------------	---------

INNER FLAME SERIES



3 Inner Burner Gas Hob RB-3CGT

WM: RM 6,404 EM: RM 6,725



Gas Input (LPG) L/R 3.6kW C 1.5kW Product Dimension W 853mm D 434mm H 66mm
Cut-out Dimension W 815mm D 405mm

- | | | |
|-----------------------|----------------------|--------------------|
| Inner Flame | High Heat Efficiency | Schott Ceran Glass |
| Timer | Safety Device | Simmer Control |
| Cast Iron Pan Support | Battery Ignition | |

2 Inner Burner Gas Hob RB-2CGT

WM: RM 4,699 EM: RM 4,934



Gas Input (LPG) L/R 3.6kW Product Dimension W 738mm D 434mm H 66mm
Cut-out Dimension W 703mm D 403mm

- | | | |
|-----------------------|----------------------|--------------------|
| Inner Flame | High Heat Efficiency | Schott Ceran Glass |
| Timer | Safety Device | Simmer Control |
| Cast Iron Pan Support | Battery Ignition | |



Inner Flame

Armed with 52% heat efficiency (JIS standards), the Inner Flame burner cooks faster and uses lesser gas than conventional gas hobs with 40% heat efficiency.



Tornado Inner Flame



Versatile Flame Settings With Simmer

Perfect flame control with powerful, controllable and even heating, providing the ideal setting to cook your favourite Asian dishes.

Save Gas And Cooking Time

The Inner Flame burner helps reduce energy, it heats the cookware from the middle - resulting in less heat lost.

3 Inner Burner Gas Hob

RB-3SI-C-S

WM: RM 2,663 EM: RM 2,797



Gas Input (LPG) L/R 3.6kW C 1.4kW

Product Dimension W 870mm D 510mm H 73mm
Cut-out Dimension W 725 - 840mm D 435 - 480mm

- Inner Flame
- High Heat Efficiency
- Stainless Steel Top
- Safety Device
- Simmer Control
- Cast Iron Pan Support
- Flexible Cut-out
- Battery Ignition

2 Inner Burner Gas Hob

RB-2GIF

WM: RM 2,100 EM: RM 2,205



Gas Input (LPG) L/R 3.5kW

Product Dimension W 780mm D 450mm H 66mm
Cut-out Dimension W 650 - 734mm D 350 - 416mm

- Inner Flame
- High Heat Efficiency
- Tempered Glass
- Safety Device
- Simmer Control
- Cast Iron Pan Support
- Flexible Cut-out
- Battery Ignition

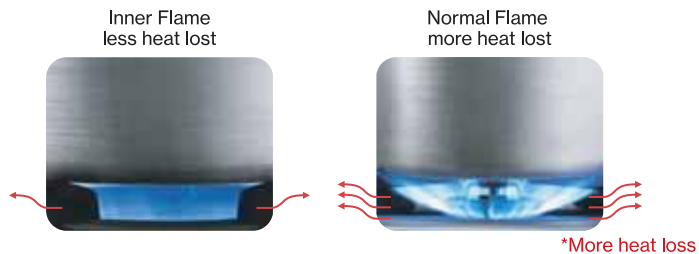

Water Boiling Test

*Based on Japan internal test

	Inner Flame	Normal Flame
Gas Input	3.6kW	4.2kW
Boiling Time	348 sec	414 sec
Heat Efficiency	52%	40%



Rinnai's Original Combustion Technology

Armed with 52% heat efficiency (JIS standards), the Inner Flame burner cooks faster and uses lesser gas than conventional gas hobs with 40% heat efficiency.



Protection From The Wind

You no longer have to worry about leaving the windows open when cooking - the Tornado Inner Flame is isolated and protected from surrounding winds.



Timer

Allows you to conveniently set cooking timer up to 4 hours for more controlled cooking. Flame will auto cut-off when time is up.



Aluminium Louvre

Oxygen can be drawn in rapidly for more efficient gas burning.



Inner Drip Pan

Overboiled soup will flow into the inner drip pan, which can be easily taken out for cleaning.

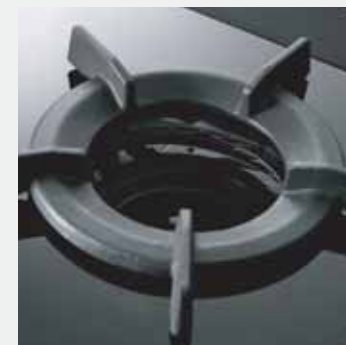

Cast Iron Pan Support

Cast iron pan support is solid and never deforms in shape. It ensures stability of your wok and pan.

LOTUS FLAME SERIES











2 Lotus Burner Gas Hob RB-L2620G-RM

WM: RM 4,699 EM: RM 4,934



Gas Input (LPG) L/R 4.2kW

Product Dimension W 755mm D 435mm H 145mm
Cut-out Dimension W 670mm D 350mm

 Lotus Triple Flame	 LED Blue Light Knob	 Simmer Control
 Sealed Burner	 Timer	 Tempered Glass
 Safety Device	 Battery Ignition	 Cast Iron Pan Support

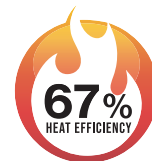

Lotus Flame

Exclusive triple-deck Lotus Burner design, with 3D flames surrounding and covering the bottom of the pot, ensuring even and complete heat distribution. It heats up quickly and efficiently, without wasting excess energy, meeting first-level heat efficiency standards of 67% (MS 1535 : 2002).



Greenovation

The 'Greenovation' platform is a breakthrough idea that brings together a synergy of 'innovative technology' and 'environmental sustainability'. 'Greenovation' is the new benchmark for real GREEN products by RINNAI. Our products reimagine the cycles of energy consumption and discharges whilst enhancing overall cooking efficiency.



Flame Control

The triple-deck Lotus Flame design allows for precise control of flame intensity, ranging from delicate simmer to powerful high flame for stir-fry, according to your preference. It enables quick and effortless adjustment to achieve the most satisfying flame.

Versatile Flame Settings With Simmer

The higher flame is ideal for stir-frying or deep-frying. The lower flame is ideal for boiling soup, braising and stewing.

Water Boiling Test

*Based on internal test

	Lotus Flame	Brand XYZ
Gas Input	4.2kW	5.0kW
Boiling Time	190 sec	249 sec
Heat Efficiency	67%	55%



Lotus Flame

Exclusive triple-deck Lotus Burner design, with 3D flames surrounding and covering the bottom of the pot, ensuring even and complete heat distribution. It heats up quickly and efficiently, without wasting excess energy, meeting first-level heat efficiency standards of 67% (MS 1535 : 2002).



Newly Designed Pan Support

The six-legged pan support design avoids direct contact with the flames, providing protection for the pan support and preventing heat dispersion. This ensures that the heat is more focused onto the bottom of the pot.

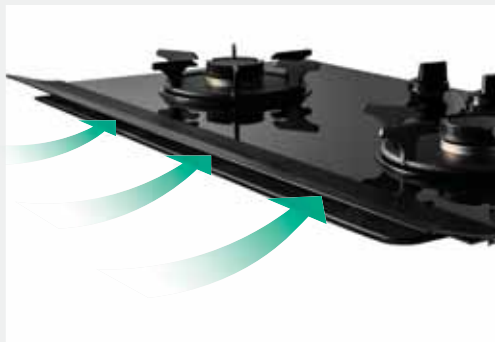

Aluminium Louvre

Oxygen can be drawn in rapidly for more efficient gas burning.



LED Blue Light Knob

The blue light synchronizes with the intensity of the flame, allowing you to control the heat without bending over.

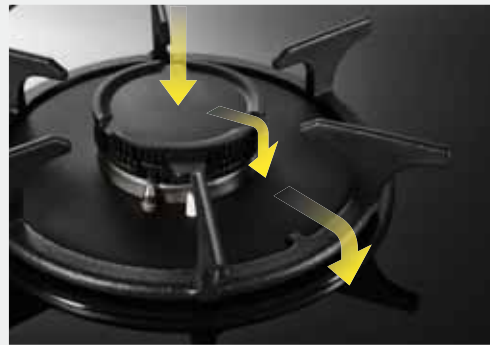

The step-like anti-leak design

Allows spilled soup to be directed towards tempered glass surface, preventing liquid from seeping into the gas hob casing and cabinet. Thus, prolonging the lifespan of the gas hob and making the countertop easier to clean.



Battery Ignition & Safety Device

Fast and easy, with no electrical wiring. When the flame is accidentally extinguished, the thermostat reacts and shuts off the gas supply to the burner. Easy to replace battery too.



Dual-burner Timer

Allows you to conveniently set cooking timer from 1 min to 240 min for more controlled cooking on both burners. Flame will auto cut-off when time is up.



Easy To Clean

The triple-deck burner eliminates the need for a drip pan, burner head or burner ring, so there are fewer parts to wash.



Cast Iron Wok Stand

Additional cast iron wok stand to support a big wok for Asian cooking or stir frying.

HYPER FLAME SERIES



3 Hyper Burner Gas Hob

RB-93UG

WM: RM 2,858 EM: RM 3,001



Gas Input (LPG)	L/R 5.5kW	C 2.0kW	Product Dimension	W 880mm	D 520mm	H 70mm
Gas Input (NG)	L/R 5.3kW	C 1.9kW	Cut-out Dimension	W 705 - 840mm	D 405 - 480mm	

- | | | |
|-----------------------|----------------------|------------------|
| Flexible Cut-out | Simmer Control | Sealed Burner |
| Schott Glass | Safety Device | Battery Ignition |
| Cast Iron Pan Support | Rubber Legs Attached | |

2 Hyper Burner Gas Hob

RB-72G

WM: RM 2,130 EM: RM 2,237



Gas Input (LPG)	L/R 5.5kW	Product Dimension	W 770mm	D 460mm	H 70mm
Gas Input (NG)	L/R 5.3kW	Cut-out Dimension	W 650 - 730mm	D 350 - 410mm	

- | | | |
|-----------------------|----------------------|------------------|
| Flexible Cut-out | Simmer Control | Sealed Burner |
| Schott Glass | Safety Device | Battery Ignition |
| Cast Iron Pan Support | Rubber Legs Attached | |



Rinnai's Most Powerful 5.5kW Flame From Japan Technology

Armed with the **Hyper Burner**, this hob features a super powerful wok-style flame to suit Asian cooking styles. It's by far the highest gas input hob among our range.

2 Hyper Burner Gas Hob

RB-92G

WM: RM 2,267 EM: RM 2,381



Gas Input (LPG) L/R 5.5kW
Gas Input (NG) L/R 5.3kW

Product Dimension W 880mm D 520mm H 70mm
Cut-out Dimension W 705 - 840mm D 405 - 480mm

- | | | |
|-----------------------|----------------------|------------------|
| Flexible Cut-out | Simmer Control | Sealed Burner |
| Schott Glass | Safety Device | Battery Ignition |
| Cast Iron Pan Support | Rubber Legs Attached | |

2 Hyper Burner Gas Hob

RB-72S

WM: RM 1,924 EM: RM 2,021



Gas Input (LPG) L/R 5.5kW

Product Dimension W 760mm D 460mm H 70mm
Cut-out Dimension W 650 - 730mm D 350 - 410mm

- | | | |
|-----------------------|----------------------|------------------|
| Flexible Cut-out | Simmer Control | Sealed Burner |
| Stainless Steel Top | Safety Device | Battery Ignition |
| Cast Iron Pan Support | Rubber Legs Attached | |

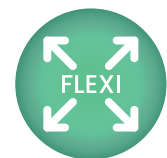

Flexible Cut-Out Size

Both the glass and stainless steel top plate fit the hob into any cut-out dimension as stated without requiring further modification to your counter-top. Good as a replacement hob!



5.5kW Flame

Emits the most powerful 5.5kW flame via the Hyper Burner to ensure maximum heating power for best flavours in cooking, especially the famous "Wok Hei" in Asian cooking.



Sealed Burner

Messy spillages are minimised and cleaning the hob is quick and easy.

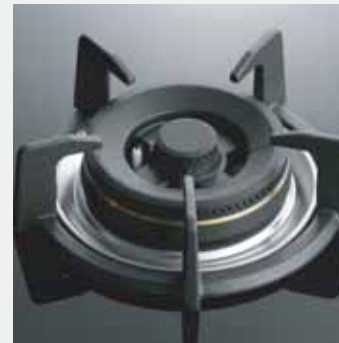

5-Legged Cast Iron Pan Support

Cast iron pan support is solid and never deforms in shape. It ensures stability of your wok and pan.



Safety Device

When the flame is accidentally extinguished, the thermostat reacts and shuts off the gas supply to the burner.



Schott Glass

Durable and heat resistant Schott Glass.

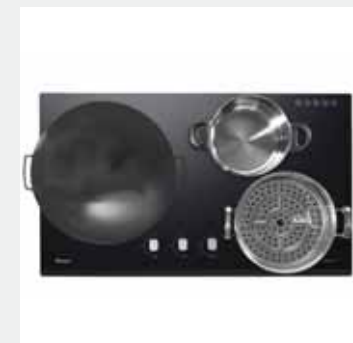

Wide Distance for Extra Cooking Space

Thoughtfully designed with ample space between burners, allowing comfortable use of a wok and two pots simultaneously.

FLEXI SERIES



flexiHob
Look nice. Fit right for most kitchen top cut-out.



3 Flexi Burner Gas Hob
RB-983G

WM: RM 2,004 EM: RM 2,105



Gas Input (LPG) L/R 5.0kW C 2.0kW

Product Dimension W 880mm D 520mm H 145mm
Cut-out Dimension W 705 - 840mm D 405 - 480mm

- Flexible Cut-out
- Simmer Control
- Sealed Burner
- Safety Device
- Tempered Glass
- Battery Ignition
- Matt Enamel Pan Support
- Rubber Legs Attached

2 Flexi Burner Gas Hob
RB-982G

WM: RM 1,674 EM: RM 1,758



Gas Input (LPG) L/R 5.0kW

Product Dimension W 880mm D 520mm H 145mm
Cut-out Dimension W 705 - 840mm D 405 - 480mm

- Flexible Cut-out
- Simmer Control
- Sealed Burner
- Safety Device
- Tempered Glass
- Battery Ignition
- Matt Enamel Pan Support
- Rubber Legs Attached

2 Flexi Burner Gas Hob
RB-782G

WM: RM 1,563 EM: RM 1,642



Gas Input (LPG) L/R 5.0kW

Product Dimension W 780mm D 460mm H 145mm
Cut-out Dimension W 650 - 730mm D 350 - 410mm

- Flexible Cut-out
- Simmer Control
- Sealed Burner
- Safety Device
- Tempered Glass
- Battery Ignition
- Matt Enamel Pan Support
- Rubber Legs Attached



3 Flexi Burner Gas Hob

RB-38HS

WM: RM 1,594 EM: RM 1,674



Gas Input (LPG) L/R 4.5kW C 1.5kW

Product Dimension W 760mm D 450mm H 150mm
Cut-out Dimension W 680 - 720mm D 380 - 410mm

- Flexible Cut-out
- Simmer Control
- Sealed Burner
- Safety Device
- Stainless Steel Top
- Battery Ignition
- Matt Enamel Pan Support
- Rubber Legs Attached

2 Flexi Burner Gas Hob

RB-27HS

WM: RM 1,489 EM: RM 1,564



Gas Input (LPG) L/R 4.5kW

Product Dimension W 730mm D 420mm H 150mm
Cut-out Dimension W 650 - 680mm D 350 - 380mm

- Flexible Cut-out
- Simmer Control
- Sealed Burner
- Safety Device
- Stainless Steel Top
- Battery Ignition
- Matt Enamel Pan Support
- Rubber Legs Attached

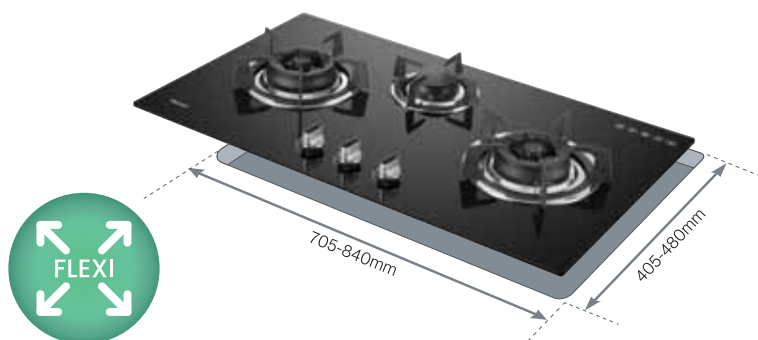

Flexible Cut-Out Size

Both the glass and stainless steel top plate fit the hob into any cut-out dimension as stated without requiring further modification to your counter-top. Good as a replacement hob!



Flame with Simmer Control

The double ring burner features a powerful flame with simmer control for greater cooking versatility and is suitable for any type of cooking from Asian to Western.



Delicate Simmer Flame

Flame can be adjusted low enough to simmer soups and stews.



Sealed Burners

Messy spillages are minimised and cleaning the hob is quick and easy.



Battery Ignition & Safety Device

Fast and easy, with no electrical wiring. When the flame is accidentally extinguished, the thermostat reacts and shuts off the gas supply to the burner. Easy to replace battery too.



Rubber Legs

The attached rubber legs allow you to place the hob directly on the kitchen workspace, without having to cut a hole or modify the kitchen top.

ECONOMY SERIES



3 Flexi Burner Gas Hob
RB-773G

WM: RM 1,576 EM: RM 1,655



Gas Input (LPG) L/R 4.5kW C 1.5kW

Product Dimension W 800mm D 460mm H 150mm
Cut-out Dimension W 680-740mm D 380-410mm

- | | | |
|-------------------------|----------------------|------------------|
| Flexible Cut-out | Simmer Control | Sealed Burner |
| Tempered Glass | Safety Device | Battery Ignition |
| Matt Enamel Pan Support | Rubber Legs Attached | |

2 Flexi Burner Gas Hob
RB-772G

WM: RM 1,250 EM: RM 1,313



Gas Input (LPG) L/R 4.5kW

Product Dimension W 800mm D 460mm H 150mm
Cut-out Dimension W 650-735mm D 350-410mm

- | | | |
|-------------------------|----------------------|------------------|
| Flexible Cut-out | Simmer Control | Sealed Burner |
| Tempered Glass | Safety Device | Battery Ignition |
| Matt Enamel Pan Support | Rubber Legs Attached | |

Domino Double Burner
RB-3312S-GBC

WM: RM 2,141 EM: RM 2,249



Gas Input (LPG) L 3.5kW S 1.7kW
Product Dimension W 310mm D 520mm H 130mm
Cut-out Dimension W 272mm D 490mm

- | | |
|------------------|-----------------------|
| Simmer Control | Sealed Burner |
| Tempered Glass | Safety Device |
| Battery Ignition | Cast Iron Pan Support |

3 Flexi Burner Gas Hob

RB-773S

WM: RM 1,500 EM: RM 1,575



Gas Input (LPG) L/R 4.5kW C 1.5kW

Product Dimension W 760mm D 450mm H 150mm
Cut-out Dimension W 680-720mm D 380-410mm

- | | | |
|-------------------------|----------------------|------------------|
| Flexible Cut-out | Simmer Control | Sealed Burner |
| Stainless Steel Top | Safety Device | Battery Ignition |
| Matt Enamel Pan Support | Rubber Legs Attached | |

2 Flexi Burner Gas Hob

RB-772S

WM: RM 1,166 EM: RM 1,225



Gas Input (LPG) L/R 4.5kW

Product Dimension W 760mm D 450mm H 150mm
Cut-out Dimension W 650-720mm D 350-410mm

- | | | |
|-------------------------|----------------------|------------------|
| Flexible Cut-out | Simmer Control | Sealed Burner |
| Stainless Steel Top | Safety Device | Battery Ignition |
| Matt Enamel Pan Support | Rubber Legs Attached | |

Domino Single Burner

RB-3311S-GBC

WM: RM 1,666 EM: RM 1,750



Gas Input (LPG) 3.5kW

Product Dimension W 310mm D 520mm H 130mm
Cut-out Dimension W 272mm D 490mm

- | | |
|------------------|-----------------------|
| Simmer Control | Sealed Burner |
| Tempered Glass | Safety Device |
| Battery Ignition | Cast Iron Pan Support |



Flame with Simmer Control

The double ring burner features a powerful flame with simmer control for greater cooking versatility and is suitable for any type of cooking from Asian to Western.



Sealed Burner

Messy spillages are minimised and cleaning the hob is quick and easy.



Delicate Simmer Flame

Flame can be adjusted low enough to simmer soups and stews.



Safety Device & Battery Ignition

Fast and easy, with no electrical wiring. When the flame is accidentally extinguished, the thermostat reacts and shuts off the gas supply to the burner. Easy to replace battery too.



Lever

Allows you to adjust the gas and air intake to achieve right mix of blue flame.

ELECTRIC HOB SERIES



Combi Vitroceramic & Induction Hob

RB-7152HEF-ZB

WM: RM 2,130 EM: RM 2,237

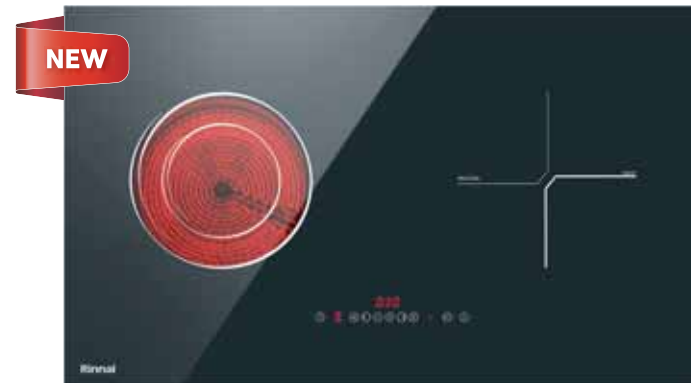

L 1.1kW / 2.2kW (ø230mm)
R 1.8kW / 2.2kW (ø210mm)
Total Power 2850W

Product Dimension W 760mm D 460mm H 58mm
Cut-out Dimension W 655-710mm D 355-430mm



Tempered Glass



9 Power Levels



Touch Sensor



Pan Recognition Sensor
(For Induction Zone)



Booster Function
(For Induction Zone)



Timer (8 hours)



Residual Heat Indicator
(For Vitroceramic Zone)



Safety Switch Off



Child Lock



Anti Overflow Protection



Stop / Go Function



Free Standing Frame

OP-FEH820530

WM: RM 500 EM: RM 525

Material

Quartz Stone

Product Dimension W 820mm D 530mm H 70mm

Cut-out Dimension W 700mm D 410mm



Free Standing Frame

Why settle for a built-in hob when you can have flexibility and style with our free-standing electric hob frame. Designed to give you an alternative to the traditional built-in. (RB-7152HEF-ZB only)



Test Your Cookware for Induction Compatibility

Induction cooking offers speed, efficiency, and safety, but it only works with the right cookware. Unsure if your pots and pans will work? Just hold a magnet to the bottom - if it sticks, they're good to go.

Timer

Allows you to conveniently set cooking timer from 0-480 minutes for more controlled cooking.

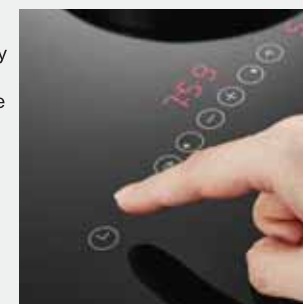

Child Lock

The control panel can be locked after programming to prevent a curious child from switching on the hob and also ensuring the hob does not accidentally get heated up during cleaning.



Combi Vitroceramic & Induction Hob

RB-7022HE-CB

WM: RM 3,455 EM: RM 3,628



L 1.1kW / 2.2kW (ø140 / 230mm)
R 1.8kW / 2.1kW (ø220mm)
Total Power 4300W

Product Dimension W 710mm D 410mm H 60mm
Cut-out Dimension W 680mm D 380mm

- | | | | |
|---------------------------------------|----------------|---|---|
| Schott Ceran Glass | 9 Power Levels | Touch Sensor | Pan Recognition Sensor (For Induction Zone) |
| Booster Function (For Induction Zone) | Timer (99 min) | Residual Heat Indicator (For Vitroceramic Zone) | Safety Switch Off |
| Child Lock | | | |

Induction Hob

RB-7013H-CB

WM: RM 3,938 EM: RM 4,135



L 1.8kW/2.1kW (ø210mm)
C 1.2kW/1.5kW (ø160mm)
R 1.8kW/2.1kW (ø210mm)
Total Power 4600W

Product Dimension W 710mm D 410mm H 58mm
Cut-out Dimension W 680mm D 380mm

- | | | | |
|--------------------|----------------|-------------------|------------------------|
| Schott Ceran Glass | 9 Power Levels | Touch Sensor | Pan Recognition Sensor |
| Booster Function | Timer (99 min) | Safety Switch Off | Child Lock |

Vitroc ceramic Hob

RB-7013E-CB

WM: RM 3,269 EM: RM 3,433



L 1.1kW/2.2kW (ø140/230mm)
C 1.2kW (ø165mm)
R 1.8kW (ø200mm)
Total Power 4100W

Product Dimension W 710mm D 410mm H 50mm
Cut-out Dimension W 680mm D 380mm

- | | | | |
|--------------------|----------------|--------------|-------------------------|
| Schott Ceran Glass | 9 Power Levels | Touch Sensor | Residual Heat Indicator |
| Safety Switch Off | Timer (99 min) | Child Lock | |



Power sharing feature optimizes energy usage and prevents overload. It distributes power among the cooking zones, allowing them to operate efficiently together. When only one zone is in use, it can utilize the maximum power (Level 9). However, when multiple zones are active, the power is alternated between them to maintain performance. The last command given to a cooking zone takes priority on the power setting.



Dual Circuit Zone

Select between smaller or larger cooking zone, depending on the size of your pots / pans, so you can save more energy.
(RB-7152HEF-ZB, RB-7022HE-CB, RB-7013E-CB, RB-6024E-CB only)



Cool To Touch

Induction hobs heat cookware directly while keeping the worktop surface cool to touch, enhancing safety. This minimizes burn risks and hot cooking environment, making it ideal for modern kitchens.



Booster Function (Induction only)

Increases to max power temporarily to quickly heat up cooking zone and save cooking time.



Residual Heat Indicator

The indicator lights up when the surface is hot to warn against hot surface and prevent accidental burn.



Induction Hobs vs Gas Hobs

Induction cooking works by creating a magnetic field that generates heat directly through the base of the cookware. Induction hobs are safe as the heat is directly transferred to the food being cooked. Even if the controls are turned on unintentionally, the hob heats up only when it detects suitable cookware placed on the cooking zone. Induction hobs boil and cook faster than gas hobs because of the heat concentration and high heat efficiency with almost no heat loss.



ELECTRIC HOB SERIES



Induction Hob RB-6024H-CB

WM: RM 4,265 EM: RM 4,479



FL 1.8kW / 2.1kW (ø210mm)
FR 1.2kW / 1.5kW (ø160mm)
RL 1.2kW / 1.5kW (ø160mm)
RR 1.8kW / 2.1kW (ø180mm)
Total Power 7200W

Product Dimension W 590mm D 520mm H 58mm
Cut-out Dimension W 560mm D 490mm



Schott Ceran Glass



9 Power Levels



Touch Sensor



Pan Recognition Sensor



Booster Function



Timer (99 min)



Safety Switch Off



Child Lock

Vitroc ceramic Hob RB-6024E-CB

WM: RM 3,196 EM: RM 3,356



FL 1.1 kW / 2.2kW (ø140mm / ø230mm)
FR 1.2kW (ø165mm)
RL 1.2 kW (ø165mm)
RR 1.8 kW (ø200mm)
Total Power 6400W

Product Dimension W 590mm D 520mm H 50mm
Cut-out Dimension W 560mm D 490mm



Schott Ceran Glass



9 Power Levels



Touch Sensor



Residual Heat Indicator



Safety Switch Off



Timer (99 min)



Child Lock

Induction Hob

RB-5022H-CB WM: RM 2,651 EM: RM 2,784



L 1.8kW/2.1kW (ø210mm) R 1.2kW/1.5kW (ø160mm)
Total Power 3400W

Product Dimension W 520mm D290mm H 58mm
Cut-out Dimension W 490mm D 270mm

- Schott Ceran Glass
- 9 Power Levels
- Touch Sensor
- Pan Recognition Sensor
- Booster Function
- Timer (99 min)
- Safety Switch Off
- Child Lock

Vitroceramic Hob

RB-5022E-CB WM: RM 2,314 EM: RM 2,430



L 1.8kW (ø200mm) R 1.2kW (ø165mm)
Total Power 3000W

Product Dimension W 520mm D290mm H 50mm
Cut-out Dimension W 490mm D 270mm

- Schott Ceran Glass
- 9 Power Levels
- Touch Sensor
- Residual Heat Indicator
- Safety Switch Off
- Timer (99 min)
- Child Lock
- Stop / Go Function

Induction Hob

RB-3022H-CB WM: RM 2,651 EM: RM 2,784



F 1.8kW/2.1kW (ø210mm) B 1.2kW/1.5kW (ø160mm)
Total Power 3400W

Product Dimension W 310mm D520mm H 58mm
Cut-out Dimension W 270mm D 490mm

- Schott Ceran Glass
- 9 Power Levels
- Touch Sensor
- Pan Recognition Sensor
- Booster Function
- Timer (99 min)
- Safety Switch Off
- Child Lock

Vitroceramic Hob

RB-3012E-CB WM: RM 2,314 EM: RM 2,430



F 1.8kW (ø200mm) B 1.2kW (ø165mm)
Total Power 3000W

Product Dimension W 310mm D520mm H 50mm
Cut-out Dimension W 270mm D 490mm

- Schott Ceran Glass
- 9 Power Levels
- Touch Sensor
- Residual Heat Indicator
- Safety Switch Off
- Timer (99 min)
- Child Lock
- Stop / Go Function



Schott Ceran Glass

When it comes to heat, Schott Ceran glass is more durable. The smooth ceramic glass surface offers practical use as well as easy maintenance.



Auto Pan Recognition Sensor (Induction Only)

Induction hobs are particularly energy saving as the cooking zone recognizes the size of the cookware, and heats up the base of the cookware instead of the whole cooking zone. It also detects right base dimensions.



Timer

Allows you to conveniently set cooking timer from 0-99 minutes for more controlled cooking.



Child Lock

The control panel can be locked after programming to prevent a curious child from switching on the hob and also ensuring the hob does not accidentally get heated up during cleaning.

PLASMA SERIES



40cm Plasma Island Hood
RH-D3154



reddot winner 2021



WM: RM 4,700 EM: RM 4,935

PLASMA AIR PURIFICATION TECHNOLOGY



RECIRCULATION ONLY

RH-D3154-BKR (Black)
RH-D3154-BLR (Blue)
RH-D3154-ORR (Orange)

Suction Power 650m³/h

Dimension W 410mm D 410mm H 590-2490mm

- | | | |
|------------------------------------|--------------------------|-------------------------|
| Plasma Air Purification Technology | LED Touch Sensor Control | Remote Control |
| Decorative LED Light | 3 Speed Settings | Booster Function |
| Delay Timer | Recirculation | Activated Carbon Filter |
| Clean & Fresh | | |

LEAVES YOUR KITCHEN FRESH & CLEAN

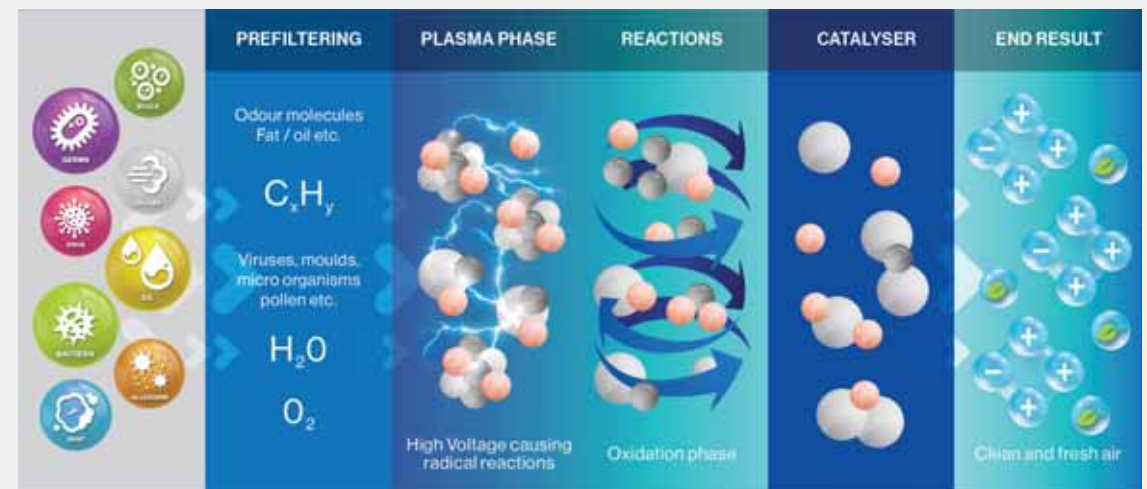



Sensor Touch Control

Touch control is extremely easy to use and indicates speed, light and delay timer.



Metal Grease Filter

An essential component that filters out grease, smoke, and other airborne particles generated during cooking. This filter with magnet is easy to take apart and clean.

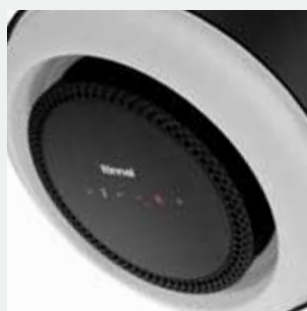

Delay Timer

The cooker hood will switch off automatically at a preset time, so you can proceed with your meal after cooking is done. Meanwhile, the cooker hood will continue to extract the oily fumes, leaving a clean kitchen without smoke or pungent smells.

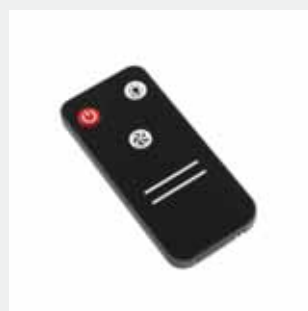

Remote Control

The remote control allows for easy operation and adjustment of the hood's settings from a distance, eliminating the need to reach or approach the appliance.



Cooker Hood

PLASMA AIR PURIFICATION TECHNOLOGY

Cleaner air in the kitchen

Developed from state-of-the-art R&D, Plasma air purification technology eliminates 98% of odours, fumes, allergens and pollutants, ensuring your kitchen always stays clean and fresh.

Intelligent Purification: How it works

Plasma purification is a process that changes the molecule composition by harnessing the power of electricity. Comes with a CPU, our Plasma filter efficiently uses a minute and safe amount of electricity to generate a voltage field that electrically charges the molecules of pollutants.

Maintenance - Free

Thanks to the plasma filter, the cooker hood doesn't require frequent cleaning. Making it hassle-free.

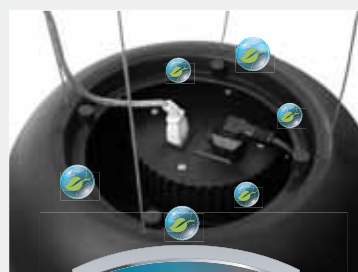

Clean and Fresh Function

How to Use?

1. Press and hold the delay timer icon for approximately 3 seconds.
2. Press the ON/OFF switch icon to start the Clean and Fresh function.
3. The timer orange ring icon will light up.
4. Clean and Fresh function is activated to run 6 mins each hour for 24 hours at speed 1.

PRESTIGE SERIES



90cm L Shape Hood

RH-L3619-PGW



Suction Power 1800m³/h

Dimension W 895mm D 380mm H 880-1310mm

WM: RM 5,100 EM: RM 5,355

PREMIUM



LED Touch Sensor Control with Wave Function

Ozone

Heat Clean

DC Motor

LED Light

Colour Changing Mood Light

3 Speed settings

Booster Function

Delay Timer

Ventilation

Recirculation

Oil Cup

Mesh Filter

Clean & Fresh

DUCT Ø180mm



Ozone Disinfection Function

The ozonizer in the cooker hood disinfects the kitchen by generating ozone, which effectively reduces cooking smells, kills bacteria and viruses. As ozone is released, it penetrates surfaces, improving air quality and reducing odors. This enhances the cooking environment and minimizes cross-contamination.



Wave Control

Touchless Smart Motion Sensor allows you to conveniently control the hood when you are inconvenient to touch the control buttons or when hands are oily. You can switch on/off the hood or change the speed settings with just a wave of your hand.

Auto Heat Clean

This feature uses a heating element to break down and eliminate accumulated grease and grime in just 9 minutes. It offers efficient, automatic cleaning that not only extends the lifespan of the cooker hood but also sterilizes the interior by killing bacteria and microorganisms.



Delay Timer

The cooker hood will switch off automatically at a preset time, so you can proceed with your meal after cooking is done. Meanwhile, the cooker hood will continue to extract the oil fumes, leaving a clean kitchen without smoke or pungent smells.



Filter Reminder

Alerts users when it's time to clean or replace the filters, ensuring optimal performance and air quality. This feature helps maintain efficient grease and odor capture, prevents airflow obstruction, and prolongs the lifespan of the cooker hood.



LED Mood Light

Adjustable LED color lighting on the cooker hood enhances the kitchen ambiance and elevates the cooking experience.



90cm L Shape Hood

RH-L3719-PBW

WM: RM 3,900 EM: RM 4,095



NEW



STANDARD



Cooker Hood

Suction Power 1700m³/h

Dimension W 895mm D 380mm H 880-1310mm

- | | | | |
|------------------|-------------|---------------|------------------|
| Heat Clean | DC Motor | LED Light | 3 Speed settings |
| Booster Function | Delay Timer | Ventilation | Recirculation |
| Oil Cup | Mesh Filter | Clean & Fresh | Ø180mm |



Wave Control

Touchless Smart Motion Sensor allows you to conveniently control the hood when you are inconvenient to touch the control buttons or when hands are oily. You can switch on/off the hood or change the speed settings with just a wave of your hand.



Auto Heat Clean

This feature uses a heating element to break down and eliminate accumulated grease and grime in just 9 minutes. It offers efficient, automatic cleaning that not only extends the lifespan of the cooker hood but also sterilizes the interior by killing bacteria and microorganisms.

Delay Timer

The cooker hood will switch off automatically at a preset time, so you can proceed with your meal after cooking is done. Meanwhile, the cooker hood will continue to extract the oil fumes, leaving a clean kitchen without smoke or pungent smells.

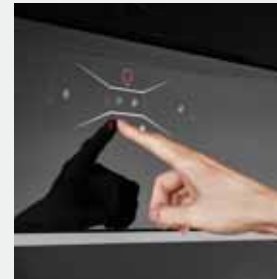

Filter Reminder

Alerts users when it's time to clean or replace the filters, ensuring optimal performance and air quality. This feature helps maintain efficient grease and odor capture, prevents airflow obstruction, and prolongs the lifespan of the range hood.



Oil Collector

The large oil cup can contain more oil.

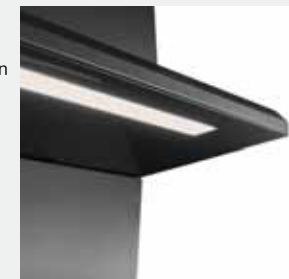

LED Light

Energy saving and long lasting LED gives out a warm natural light.

ELITE SERIES



90cm Chimney Hood

RH-C3819-PBW

WM: RM 3,300 EM: RM 3,465



NEW



Suction Power 1700m³/h

Dimension W 895mm D 490mm H 630-1090mm



Heat Clean



DC Motor



LED Light



3 Speed settings



Booster Function



Delay Timer



Ventilation



Recirculation



Oil Cup



Baffle Filter



Clean & Fresh



DUCT Ø180mm

Inner Flue Extension *Optional accessory

W-YX-1371-1-120

Additional piece of chimney flue extension of 1200mm height is available for purchase. Suitable for ceiling height up to 11 feet.

WM: RM 386 EM: RM 406

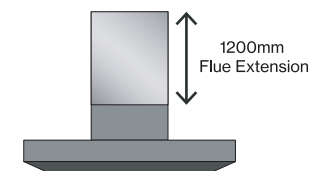

Wave Control

Touchless Smart Motion Sensor allows you to conveniently control the hood when you are inconvenient to touch the control buttons or when hands are oily. You can switch on/off the hood or change the speed settings with just a wave of your hand.



Auto Heat Clean

This feature uses a heating element to break down and eliminate accumulated grease and grime in just 9 minutes. It offers efficient, automatic cleaning that not only extends the lifespan of the cooker hood but also sterilizes the interior by killing bacteria and microorganisms.

Baffle Filter with Wire

Baffle filters come with a grease trap and the filters are sloped, so any grease and moisture that is captured will drip into the grease collector at the back of the hood. With a wire hooked onto the filter, you can take them out without worrying accidental drop.



Delay Timer

The cooker hood will switch off automatically at a preset time, so you can proceed with your meal after cooking is done. Meanwhile, the cooker hood will continue to extract the oil fumes, leaving a clean kitchen without smoke or pungent smells.



Oil Collector

The large oil cup can contain more oil.

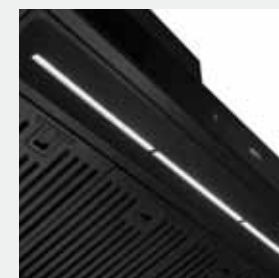

LED Light

Energy saving and long lasting LED gives out a warm natural light.



90cm Chimney Hood

RH-C1059-PBW

WM: RM 3,477 EM: RM 3,651



Suction Power 1200m³/h

Dimension W 898mm D 500mm H 550-1030mm

	LED Touch Sensor Control		Decorative LED Light		3 Speed settings
	Booster Function		Delay Timer		Oil Cup
	Mesh Filter		Ventilation		Recirculation
	Rectifier Panel		Clean & Fresh		Ø150mm

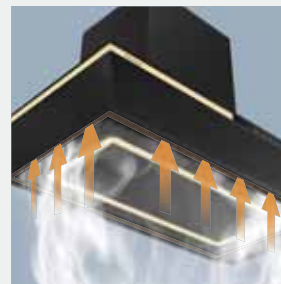

Rectifier Panel

Full acceleration speeds up the extractions of smoke and grease.



Clean and Fresh

Discover the ultimate solution for a spotless and refreshing kitchen atmosphere. Once activated, Clean and Fresh function is preset to work for 6 mins each hour for 24 hours at fan setting speed 1. Say goodbye to grease, odours and stale air, and welcome a new era of cooking comfort and cleanliness.

Oil Cup

The Oil Cup under the extraction motor will collect oil from the air that passes the mesh filter, suitable for Asian cooking.



Sensor Touch Control

Touch control is extremely easy to use and indicates speed, light and delay timer.



Mesh Filter

Easy to take apart and clean.



Delay Timer

The cooker hood will switch off automatically at a preset time, so you can proceed with your meal after cooking is done. Meanwhile, the cooker hood will continue to extract the oil fumes, leaving a clean kitchen without smoke or pungent smells.

DESIGNER SERIES



90cm Chimney Hood

RH-C91B-SSW

WM: RM 3,998 EM: RM 4,198



Suction Power 1700m³/h

Dimension W 898mm D 500mm H 585-1030mm

- Heat Clean
- DC Motor
- LED Light
- 3 Speed settings
- Booster Function
- Delay Timer
- Ventilation
- Recirculation
- Oil Cup
- Rectifier Panel
- Clean & Fresh
- DUCT Ø180mm

Inner Flue Extension *Optional accessory

W-YX-17284-120

Additional piece of chimney flue extension of 1200mm height is available for purchase. Suitable for ceiling height up to 11 feet.

WM: RM 386 EM: RM 406

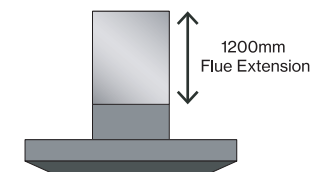

Wave Control

Touchless Smart Motion Sensor allows you to conveniently control the hood when you are inconvenient to touch the control buttons or when hands are oily. You can switch on/off the hood or change the speed settings with just a wave of your hand.



Auto Heat Clean

This feature uses a heating element to break down and eliminate accumulated grease and grime in just 9 minutes. It offers efficient, automatic cleaning that not only extends the lifespan of the cooker hood but also sterilizes the interior by killing bacteria and microorganisms.

Rectifier Panel

Full acceleration speeds up the extractions of smoke and grease.



Magnetic Lock

Rectifier panel can be easily detached for cleaning. Save the hassle of loosening the mounting screws



Delay Timer

The cooker hood will switch off automatically at a preset time, so you can proceed with your meal after cooking is done. Meanwhile, the cooker hood will continue to extract the oil fumes, leaving a clean kitchen without smoke or pungent smells.



Oil Collector

The large oil cup can contain more oil.

90cm Chimney Hood
RH-C1159-PBW

WM: RM 2,451 EM: RM 2,574



Suction Power 1350m³/h

Dimension W 895mm D 504mm H 567-1045mm

Electronic Touch Control with Wave Function	DC Motor	LED Strip Light	3 Speed Settings
Booster Function	Delay Timer	Ventilation	Recirculation
Oil Cup	Baffle Filter	Clean & Fresh	Ø150mm

90cm Inverter Motor Slanted Hood
RH-KT2959-GBV

WM: RM 3,300 EM: RM 3,465



Suction Power 1350m³/h

Dimension W 895mm D 490mm H 970-1450mm

LED Touch Sensor Control	DC Motor	LED Strip Light	Colour Changing Mood Light
3 Speed Settings	Booster Function	Delay Timer	Oil Cup
Baffle Filter	Ventilation	Clean & Fresh	Ø180mm

* 7 inch end cap and aluminium hose included.



Wave Control

Touchless Smart Motion Sensor allows you to conveniently control the hood when you are inconvenient to touch the control buttons or when hands are oily. You can switch on/off the hood or change the speed settings with just a wave of your hand.



Clean and Fresh

Discover the ultimate solution for a spotless and refreshing kitchen atmosphere. Once activated, Clean and Fresh function will operate 5 mins every hour for up to 24 hours. Say goodbye to grease, odours and stale air, and welcome a new era of cooking comfort and cleanliness.



Delay Timer

The cooker hood will switch off automatically at a preset time, so you can proceed with your meal after cooking is done. Meanwhile, the cooker hood will continue to extract the oil fumes, leaving a clean kitchen without smoke or pungent smells.



Oil Collector

The large oil cup can contain more oil.



Baffle Filter

Grease and moisture will be captured by the specially designed, sloped Baffle Filter. It will subsequently filter and trap them in a specially-built grease collector, located at the rear of the hood.



LED Light

Energy saving and long lasting LED gives out a warm natural light.

CHIMNEY SERIES



90cm Chimney Hood
RH-C1119-GCW

WM: RM 2,451 EM: RM 2,574



Suction Power 1200m³/h **Dimension** W 898mm D 460mm H 575-1035mm

- | | | |
|--------------------------|---------------|------------------|
| LED Touch Sensor Control | LED Light | 3 Speed Settings |
| Delay Timer | Ventilation | Recirculation |
| Oil Cup | Baffle Filter | Ø150mm |

90cm Chimney Hood
RH-C95F-SSVR

WM: RM 1,608 EM: RM 1,689



Suction Power 1200m³/h **Dimension** W 895mm D 500mm H 548-1000mm

- | | | |
|--------------------------|-----------------------|------------------|
| LED Touch Sensor Control | LED Light | 3 Speed Settings |
| Delay Timer | Ventilation | Recirculation |
| Oil Cup | Aluminium Mesh Filter | Booster Function |
| Clean & Fresh | Ø150mm | |

SLIM SERIES











90cm Slim Hood

RH-S259-SSV-T 

RH-S259-SSR-T  WM: RM 1,614 EM: RM 1,695



Suction Power 515m³/h
Dimension W 898mm D 515mm H 140mm









-  Sensor Touch Control
-  LED Light
-  4 Speed Settings
-  Delay Timer
-  Oil Cup
-  Rectifier Panel
-  Ventilation
-  Recirculation
-  Ø150mm

90cm Slim Hood

RH-S3059-PBW WM: RM 1,082 EM: RM 1,137



Suction Power 580m³/h
Dimension W 898mm D 495mm H 110mm







-  LED Touch Sensor Control
-  Decorative LED Light
-  3 Speed settings
-  Delay Timer
-  Recirculation
-  Ventilation
-  Mesh Filter
-  Ø120mm

90cm Slim Hood

RH-S95A-SSVR WM: RM 736 EM: RM 773



Suction Power 490m³/h
Dimension W 896mm D 496mm H 100mm







-  Mechanical Control
-  LED Light
-  3 Speed Settings
-  Ventilation
-  Recirculation
-  Ø120mm

90cm Telescopic Hood

RH-TL95C-SSVR WM: RM 1,016 EM: RM 1,067



Suction Power 600m³/h
Dimension W 899mm D 298mm H 243mm







-  Mechanical Control
-  LED Light
-  2 Speed Settings
-  Ventilation
-  Recirculation
-  Auto On/Off Switch
-  Ø120mm

60cm Slim Hood

RH-S65A-SSVR WM: RM 590 EM: RM 620



Suction Power 490m³/h
Dimension W 596mm D 496mm H 100mm







-  Mechanical Control
-  LED Light
-  3 Speed Settings
-  Ventilation
-  Recirculation
-  Ø120mm

60cm Telescopic Hood

RH-TL65C-SSVR WM: RM 864 EM: RM 908



Suction Power 600m³/h
Dimension W 599mm D 298mm H 243mm

-  Mechanical Control
-  LED Light
-  2 Speed Settings
-  Ventilation
-  Recirculation
-  Auto On/Off Switch
-  Ø120mm

ELECTRIC OVEN SERIES



*Fresh out from Europe
to your kitchen*

60CM Oven
RO-E6533T-EB

WM: RM 7,500 EM: RM 7,875



Overall Dimension W 595mm D 564mm H 595mm
Cut-out Dimension W 560mm D 550mm H 585mm

Temperature setting: 30c - 300c

- | | | |
|--|----------------------------------|-----------------------------|
| Super Size Capacity: 77lt | 21 Functions | 3D Circular Heating |
| Rotary Knobs With Touch Control Panel | Triple Glazed Cool-to-touch Door | Gentle Open And Close Door |
| Dynamic Oven Cooling Plus (Reduce Temperature to 60°C) | Telescopic Pull-Out Rail | Air Fry |
| Gratin | Fast Preheat | EcoClean Enamel |
| Step Bake | 22 Automatic Programmes | Energy Efficiency Class: A+ |

Functions

- | | | | |
|------------------------------|----------------------|-----------------------------|--------------------------------|
| 3D Hot Air | Pizza System | Air Fry | Grill with Hot Air |
| Turbo Bake | Large Grill | Top & Bottom Heater | Gentle Bake |
| Top & Bottom Heater With Fan | Large Grill With Fan | Large Grill & Bottom Heater | Grill With Bottom Heater & Fan |
| Oven Light | | | |

Automatic Modes

- | | | | |
|-------------|-----------------|-----------|---------|
| Frozen Bake | Auto Pizza Mode | Slow Bake | Air Fry |
|-------------|-----------------|-----------|---------|

Extra Functions

- | | | | |
|------------|---------|-----------|---------------|
| Aqua Clean | Defrost | Reheating | Plate Warming |
|------------|---------|-----------|---------------|



Simultaneous Cooking

The circular heating distributes heat evenly so that you can cook different types of food on different shelves simultaneously without worrying that the smells and tastes will be transferred from one dish onto another.

Automatic Programmes

The oven holds 22 unique recipes to choose between numerous automatic programs. Great for beginners as well as experienced home cooks. With pre-programmed configurations for time, temperature and functions, all the user needs to do is to select their dish, its weight and press start.

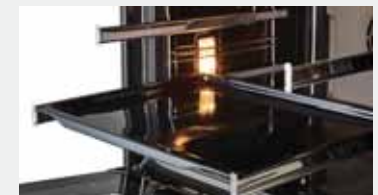

Telescopic Pull-Out Rail

Telescopic rails are the perfect assistant and partner for your oven. They help manoeuvre heavy trays with ease in and out of the oven. This way you don't have to worry about the close exposure to high heat and the risk of spilling or dropping your food.

60CM Oven
RO-E6523M-EB

WM: RM 5,600 EM: RM 5,880



60CM Oven
RO-E6513M-ES

WM: RM 4,950 EM: RM 5,198



Overall Dimension W 595mm D 564mm H 595mm
Cut-out Dimension W 560mm D 550mm H 585mm

Temperature setting: 50c - 300c

- Super Size Capacity: 77lt
- Push-Pull Rotary Knobs With Touch Control Panel
- Dynamic Oven Cooling Plus (Reduce Temperature to 60°C)
- Gratin
- Energy Efficiency Class: A
- 13 Functions
- Triple Glazed cool-to-touch Door
- Click on Pull-Out Rail x 2
- Fast Preheat
- 3D Circular Heating
- Gentle Open and Close Door
- Air Fry
- EcoClean Enamel

Overall Dimension W 595mm D 564mm H 595mm
Cut-out Dimension W 560mm D 550mm H 585mm

Temperature setting: 50c - 300c

- Super Size Capacity: 77lt
- Push-Pull Rotary Knobs With Touch Control Panel
- Air Fry
- EcoClean Enamel
- 13 Functions
- Double Glazed Oven Door
- Gratin
- Energy Efficiency Class: A
- 3D Circular Heating
- Dynamic Oven Cooling Plus (Reduce Temperature to 60°C)
- Fast Preheat

Functions

- Fast Preheat
- Top & Bottom Heater With Fan
- Large Grill With Fan
- Intensive Baking (Air Fry)
- 3D Hot Air
- Top & Bottom Heater
- Large Grill
- Gentle Bake
- Pizza System
- Frozen Bake
- Defrost
- Oven Light
- Aqua Clean



Gentle Open and Close Door
The smart high quality hinge design means that opening and closing the oven door is smoother and quieter than ever.

*Only for RO-E6533T-EB & RO-E6523M-EB



Gratin
Gratination process is used in the final stage of baking and will run for 10 minutes, to get a golden yellow crust on the dish. This process protects the dish from drying while giving it a nicer look and better taste.



Fast Preheat
Charmingly fast, saving time and energy. The oven reaches a temperature of up to 200°C in just 4 minutes, saving 30% of the time needed by standard preheating. A light and sound signal informs when the temperature is right.

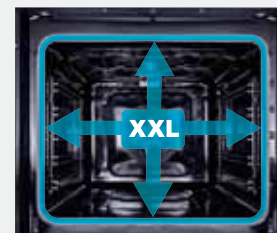

77lt Super Size Cavity
The 77lt extra-large cavity offers you extra space for flexible cooking. More spacious oven allows you to cook a larger quantity of food - 46cm wide baking trays.

Cool-to-Touch Triple Glazed Oven Door
The low-e glass reflects heat back into the oven, boosting safety and efficiency. It helps to keep the oven door cool while it is in use.

*Only for RO-E6533T-EB & RO-E6523M-EB



Air Fry
This method of baking gives the food a crispy crust, without added fat. It is a healthy version of "fast food" with a lower calorie content. Suitable for small cuts of meat, fish, vegetables and pre-prepared frozen products.



Aqua Assisted Cleaning
AquaClean offers great assistance in cleaning the oven cavity. All it takes is to pour 0.4 litre of water into a baking tray and turn AquaClean on after each baking. This function is using bottom heater at 70°C in just 30 minutes. Stains and grease are softened and can be easily wiped away.



Built-in Oven

60cm Oven
RO-E6208TA-EM

WM: RM 3,246 EM: RM 3,409



Overall Dimension W 594mm D568.8mm H 594mm
Cut-out Dimension W 558mm D 550mm H 595mm
Temperature setting: 60c - 260c

- 3D Circular Heating
- Mirror Reflective Glass With Stainless Steel Frame
- Triple Glazed Removable Glass Door
- Rotary Knobs With Touch Control Panel
- Digital Timer With Auto End Cook
- Cooling Fan
- Rotisserie
- Energy Efficiency Class: A
- Extra-large Capacity: 70lt

Functions

- Oven Light
- Top & Bottom Heating Elements / Conventional
- Bottom Heating with Fan / Delicate Cook
- Grill
- Upper Heater
- Grill and Fan
- Circular Heating Elements with Fan / 3D Hot Air
- Defrost

60cm Oven
RO-E6206XA-EM

WM: RM 2,872 EM: RM 3,016



Overall Dimension W 594mm D568.8mm H 594mm
Cut-out Dimension W 558mm D 550mm H 595mm
Temperature setting: 60c - 260c

- Mirror Reflective Glass With Stainless Steel Frame
- Triple Glazed Removable Glass Door
- Rotary Knobs With Electronic Display
- Digital Timer With Auto End Cook
- Cooling Fan
- Rotisserie
- Energy Efficiency Class: A
- Extra-large Capacity: 70lt

Functions

- Oven Light
- Grill and Fan
- Grill
- Top & Bottom Heating Elements with Fan
- Upper Heater
- Top & Bottom Heating Elements / Conventional



Multifunction

Each function is designed to give you the most ideal cooking method to suit your recipe and to provide the best results. For e.g, Fan & Grill function ensure your large roast is being cooked through.

Removable Door

The glass door can be detached easily so that the oven cavity can be cleaned more easily and thoroughly.



Extra-Large Cavity

The 70lt extra-large cavity offers you extra space for flexible cooking.



Sensor Touch Timer

You can use the timer to count down the cooking time or program your oven to start/stop at a particular time.



3D Circular Fan

The circular heating distribute heat evenly so that you can cook different types of food on different shelves simultaneously without worrying that the smells and tastes will be transferred from one dish onto another.

Measurements in mm.

* For bench top installation, minimum 5mm ventilation gap is required on both sides of appliance. If oven installed below a hob, minimum 30mm ventilation gap is required between hob and oven or refer to required distance instructed in the hob manufacturer's instruction manual. Follow the higher distance if in doubt.

HOWARO C SERIES

HOWARO C

Table Top Cooker with Grill

RTC-6912SG-EWS-RM

WM: RM 2,292 EM: RM 2,407



Water Boiling Mode



Rice Cooking Mode

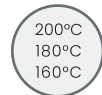

Deep Fry Temperature Control



Gas Input (LPG)

High Flame Burner (L): 4.2kW Standard Burner (R): 2.97kW
Grill: 2.0kW

Ignition System Continuous Spark

Dimension W 596mm D 495mm H 180mm



Timer



Temperature Sensor



360° Grill



Auto-Adjust Flame Level



Ignition Safety Lock



Safety Auto Cut-Off



360° Heating

Heat is circulated evenly to achieve maximum taste of the grills.

Temperature Sensor

Temperature can be set according to cooking, like high temperature frying, water boiling or rice cooking mode.



Wide Plate

Whole fish can be fitted easily onto the Cocotte Plate.

Rinnai Exclusive Cocotte Plate

Wave-like design of the plate with side drains to catch excess oil drippings.



Table Top Cooker with Grill

LAUNDRY SERIES



Gas Clothes Dryer
RDT-90-RM-S

WM: RM 4,515
EM: RM 4,741



Overall Dimension W 650mm D 641mm H 684mm

Maximum Drying Content: 9kg	Gas Consumption: 4.65kW (4000kcal/h)
Standard Drying Time: 90 min (approximately)	Weight (Body only): 33kg
Power Consumption: 250W (at standby, 0.2W)	Power Cord Length: 1.5 meters
Function: General, Thick, Eco, Sheet/ Blanket Self clean	

Gas Clothes Dryer
RDT-62-RM-W

WM: RM 3,712
EM: RM 3,898



Overall Dimension W 650mm D 561mm H 684mm

Maximum Drying Content: 6-6.5kg	Gas Consumption: 4.65kW (4000kcal/h)
Standard Drying Time: 60 min (approximately)	Weight (Body only): 30kg
Power Consumption: 250W (at standby, 0.2W)	Power Cord Length: 1.5 meters
Function: General, Thick & Extra, Warm, Delicate, Timer, Fast 1KG	

Optional accessory



Standing Rack
OP-LDS-80HSF
WM: RM 550 EM: RM 578



Wall Rack
OP-WS-60HSF
WM: RM 280 EM: RM 294



2 Weeks On-site Free Trial

We have a Free 14-Day Demo for our gas clothes dryer, where our technician will install the dryer at your home, along with a gas cylinder. During this 14-Day Demo period, you are free to use the gas dryer as you wish and ask us any questions about it!

At this moment, we only offer the Free 14-Day Demo to Klang Valley. If you are currently from outside of Klang Valley, we can arrange depending on location and case-by-case basis.

EXTRA SOFT & FLUFFY

Very fluffy! Much difference!

18cm 19cm 21.5cm

	UNDER SUN	ELECTRIC DRYER	GAS DRYER
COST	0	\$\$\$\$	\$\$
FLUFFINESS	👍	👍👍	👍👍👍
DRYING TIME	👍	👍👍	👍👍👍
ANTI-BACTERIA	👍👍👍👍	👍👍👍	👍👍👍
SPACE	👍	👍👍👍👍	👍👍👍
WEATHER	👍	👍👍👍👍	👍👍👍

Soft & Fluffy

- A built-in microchip sensor constantly monitors humidity at half-second intervals to prevent over drying.
- Water vapour produced during gas combustion keeps your clothes soft & fluffy.

KILLS MORE THAN 99% OF GERMS



Indoor Drying Increases Bacteria Growth

Drying laundry indoors may lead to rapid growth of bacteria on clothes. As a result, your clothes may smell, and you're more susceptible to diseases such as otitis media, asthma and respiratory infection.

DRYING TIME

1.28 hrs	2.23 hrs
Rinnai Gas Dryer	Electric Dryer

Speedy & Economy

- Gas heats up the air intake much quicker than electricity. That's why a gas dryer needs only half the time required by electric dryer to dry the same load.
- Gas heat eliminates microorganisms or dust from your laundry.
- Long term energy saving of about 20% are yours to enjoy.



Easy Operation

- A computerized user-friendly control panel offers the ease of one-touch operation.
- There are different programs to suit different fabric materials.
- With the built-in sensor, you don't even need to set a timer to ensure best drying results.



Outdoor Drying Exposes Clothes to Pollutants

Poor outdoor air quality means that the laundry hung outside for long period of time would accumulate large quantity of PM2.5 particles (atmospheric particulate matters that have a diameter of less than 2.5 micrometers) that can cause skin allergy among children.

Comparison disinfection of E.coli (Escherichia coli)

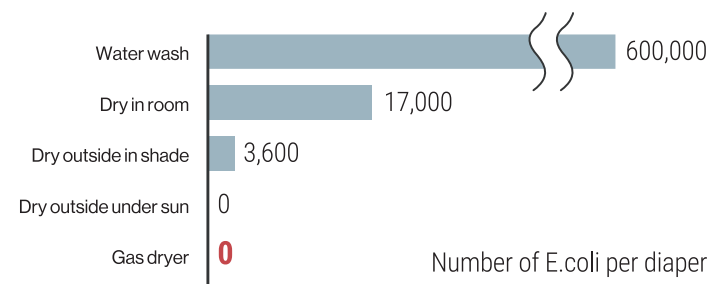

Ideal for baby clothes drying

Our dryer demonstrates the same level of disinfection effect as sun-dried. Moreover, since there is no need for external drying, there is no worry that particulates such as dust and exhaust gas will adhere.



Fast 1KG Quickie

< 20 min quick drying of small amount of clothes for 1kg

WATER HEATING SYSTEM SERIES



Infinity 26 External Gas Water Heater REU-A2626WD-GEN

WM: RM 3,798 EM: RM 3,988



Remote Controller

MC-601-A (UC)

(optional accessory)

WM: RM 280 EM: RM 294



Gas Input (LPG/NG) Input Rating Max: 47,500 kcal/h
Input Rating Min: 4,000 kcal/h

Operation 220v-240v / 50Hz-60Hz

Multi Supply Points 4-5 Bathrooms

* Multi Supply Points: The number of point the Gas Hot Water Heater can supply depends on water pressure, ambient water temperature and the outlets' water flow capacity.

Factory Pre-set Temp 55°C

Fixed Temp by DipSW 40,42,50,55,60,65°C

Casing Colour Euro White

Product Dimension W 356mm D 182mm H 503mm

👑 Superior Japanese Technology & Quality

★ 5 Star Energy Ratings

📏 Compact Size & Space Saving

🌱 Environmental Friendly

🛡️ Highly Safe & Efficient

🌊 Endless Hot Water

💰 Economical Operation

🔄 Multiple Point Connections

⚡ Rapidstart Technology for Faster Hot Water

🔌 Easy Connection For Controller

🔌 No Transformer

Mixer Option

Notes

1. HEATER TEMPERATURE PRESET @ 55 C
2. MANUALLY ADJUST SHOWER/TAP TEMPERATURE USING MIXER
3. SEPARATE HOT & COLD PIPING ARE REQUIRED

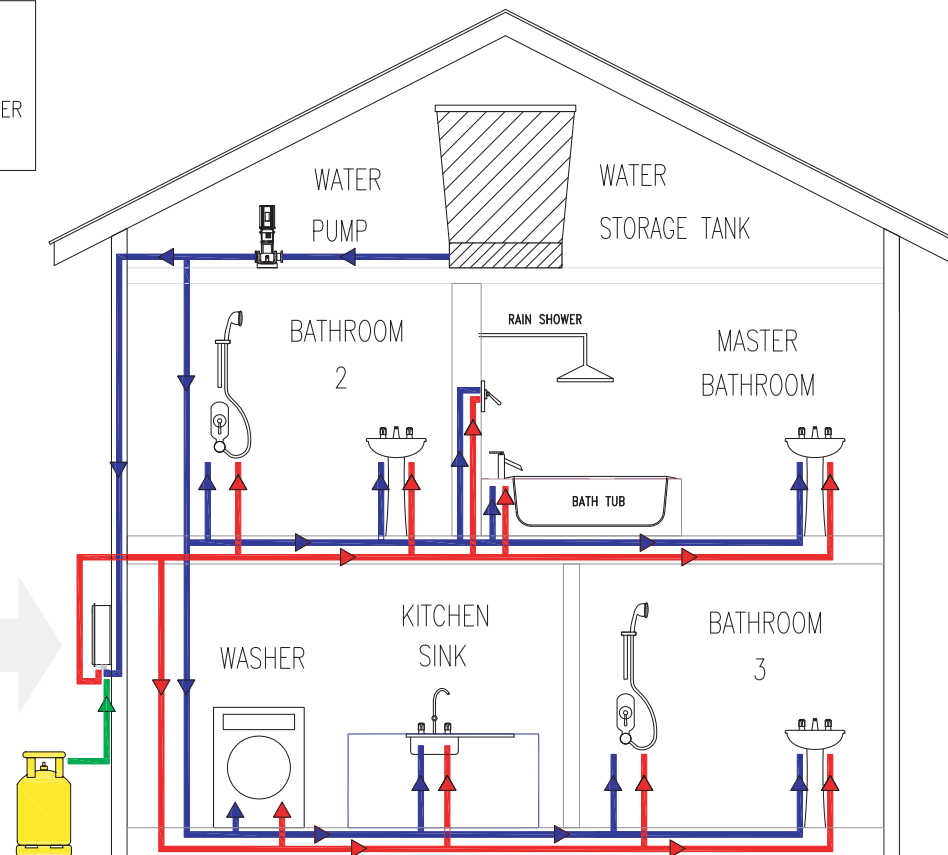
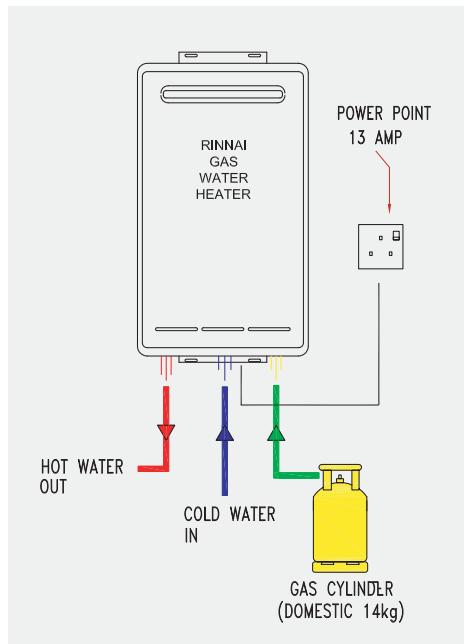

Remote Auto Setting

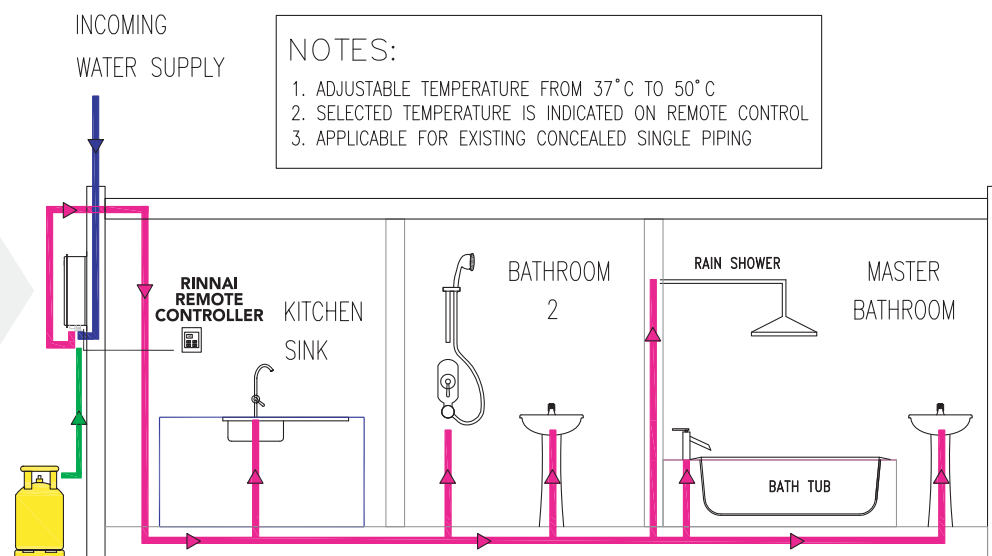
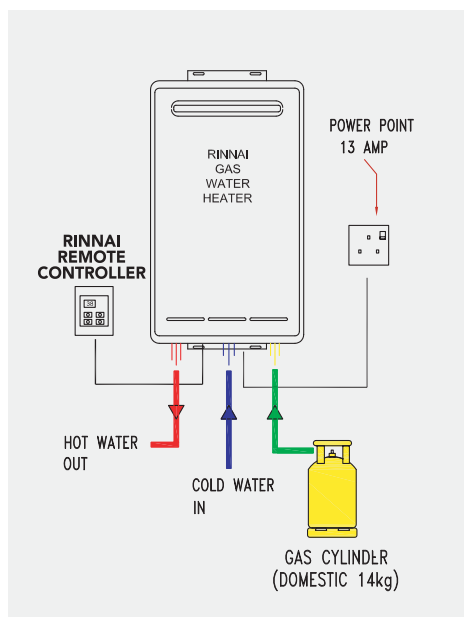

NOTES:

1. ADJUSTABLE TEMPERATURE FROM 37°C TO 50°C
2. SELECTED TEMPERATURE IS INDICATED ON REMOTE CONTROL
3. APPLICABLE FOR EXISTING CONCEALED SINGLE PIPING

AQUARIUS SERIES



AQUARIUS

Digital Thermostatic Instant Water Heater

Gunmetal Grey

REI-F380DP-BL (DC Inverter Pump)

WM: RM 858

EM: RM 900



Triple Safety Protection

Shock proof protection
3 stage thermal protection
RCD protection



ACTIVESHIELD

RCD rated 10 mA
to cut off electricity in
case of current leakage



3 Memory Shower Mode

Cold
Eco (36°C)
Hot (40°C)



Thermostatic Constant Temp

Dual thermistor



Low Pressure

Pump activator



Energy Saving

DC inverter
55w turbo pump

Easy Switching 3-Spray Showerhead

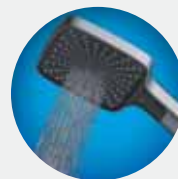

Spot Spray

Concentrated spray
to relax tense area.

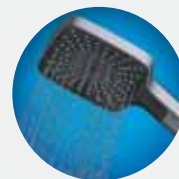

Saturating Spray

Intense jets of micro-
droplets to cleanse your
body from lethargy.

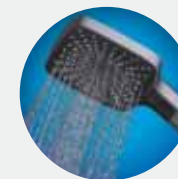

Mix Spray

Mix spray that combines
rich yet soft and strong
revitalizing water texture.

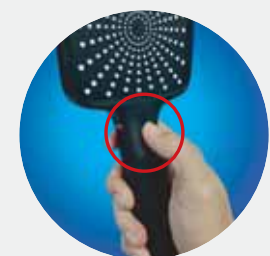

3-Way Shower Selector

The switch selector on the shower head
provides 3-way control of the shower flow:
Spot, Saturating, or Mix Spray.

The Selector Button is built into the grip
for easy access, allowing you to switch
the spray with a single hand.

SEN SERIES

SEN SERIES

ELECTRIC INSTANT WATER HEATER



Black Rock (BK)
 REI-E380DP-BS-BK WM: RM 639
 (DC Inverter Pump) EM: RM 671
 REI-E380NP-BS-BK WM: RM 426
 (Without Pump) EM: RM 448



Sandy Beach (BG)
 REI-E380DP-C-BG WM: RM 591
 (DC Inverter Pump) EM: RM 621
 REI-E380NP-C-BG WM: RM 380
 (Without Pump) EM: RM 399



Cirrus Cloud (WH)
 REI-E380DP-B-WH WM: RM 551
 (DC Inverter Pump) EM: RM 579
 REI-E380NP-B-WH WM: RM 317
 (Without Pump) EM: RM 333

Optional accessory

RRS-B2XX

[* Without hand shower and exclude hose.
 * Matte black finishing.]

WM: RM 328 EM: RM 345

RRS-C2XX

[* Without hand shower and exclude hose.
 * Chrome finishing.]

WM: RM 279 EM: RM 293



High-power hot shower

With 3.8kW heating capacity that shortens heating time, provides hot water faster to give you instantly relaxing hot shower, especially on a cold day.



Earth Leakage Circuit Breaker (ELCB)

Cuts off electricity supply in the event of current leakage.

Key Features

- 1-Knob Control**
Easy temperature control with a turn.
- Lightning & Surge Protection**
Built-in surge protector protects from lightning strikes and current leakage.
- Dual Over Temperature Safety Cut-Off**
Avoids overheating and scalding with auto-reset if water temperature exceeds set limit.
(Primary cut-off: 55°C; Secondary cut-off: 90°C)
- IP25 Splash-Proof Protection**
ABS plastic waterproof casing is in compliant with IP25 Safety Standard to prevent water and dust.
- Auto Flow Sensor Switch**
Shuts off heater automatically to avoid dry burn when water flow is too low.
- 5-Multi Spray Handshower**
Comes with a choice of 5 classic spray nozzles.

Warranty

10 YEARS
Anti-Leak Tank

5 YEARS
Heating Element

5 YEARS
DC Pump

2 YEARS
Internal Parts



Hot / Normal Water Faucet

Additional hot water source for baby bathtub, clothes pail, pet shower and other usage.

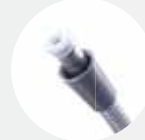

Anti-Twist Hose

Prevents low water flow due to twisted hose.



Electric Instant Water Heater

HEAVY COOKING SERIES



RTL-35KS (Stainless Steel)
RTL-35K (Grey)

WM: RM 441 EM: RM 464
WM: RM 407 EM: RM 428

6.7
kW



Burner
Top Plate
Dimensions
Form of Ignition
Gas Consumption(LPG)

Cast Iron
Stainless Steel
W 360mm D 480mm H 200mm
Piezo Ignition
6.7kW

RT-702SCC

WM: RM 633 EM: RM 665

5.25
kW

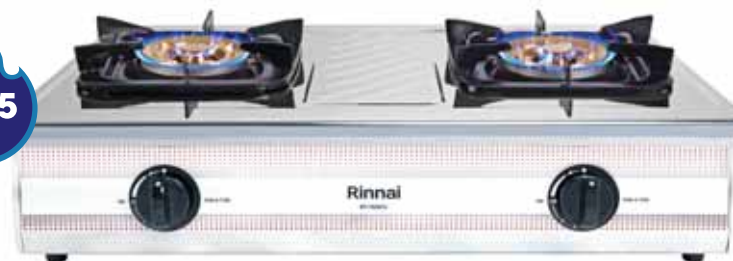

Burner
Top Plate
Dimensions
Form of Ignition
Gas Consumption(LPG)

Cast Iron / Brass
Stainless Steel
W 694mm D 468mm H 201.5mm
Piezo Ignition
L 5.25kW R 5.25kW



Double Ring Burner - Strong flame for Asian cooking

RI-4RSPN

WM: RM 1,455 EM: RM 1,528

6.0
kW



Burner
Top Plate
Dimensions
Form of Ignition
Gas Consumption(LPG)

Cast Iron
Stainless Steel
W 864mm D 486mm H 198.5mm
Piezo Ignition
L 6.0kW C 2.3kW R 6.0kW



RI-2RSPN

WM: RM 923 EM: RM 970

6.0
kW



Burner
Top Plate
Dimensions
Form of Ignition
Gas Consumption(LPG)

Cast Iron
Stainless Steel
W 750mm D 486mm H 198.5mm
Piezo Ignition
L 6.0kW R 6.0kW



DOMESTIC COOKING SERIES

RI-712Si

WM: RM 726 EM: RM 763

2.9
kW



Burner Stainless Steel
Top Plate Stainless Steel
Dimensions (mm) W 720mm D 415mm H 200mm
Form of Ignition Battery Size "C" 1.5V
Gas Consumption(LPG) L 2.9kW R 2.9kW



Inner Flame Burner (Intensive flame focus) Safety Device



RI-602 HTB-S

WM: RM 378 EM: RM 397

4.5
kW



Burner Stainless Steel / Brass
Top Plate Stainless Steel
Dimensions (mm) W 720mm D 380mm H 141mm
Form of Ignition Piezo Ignition
Gas Consumption(LPG) L 4.5kW R 4.5kW



Tornado Burner - Powerful flame & high durability



RI-522M

WM: RM 300 EM: RM 315

4.8
kW



Burner Stainless Steel / Brass
Top Plate Stainless Steel
Dimensions (mm) W 700mm D 378mm H 157mm
Form of Ignition Piezo Ignition
Gas Consumption(LPG) L 3.8kW R 4.8kW



Mega Burner - Powerful flame (for right burner only)

RI-522MM

WM: RM 366 EM: RM 385

4.8
kW



Burner Stainless Steel / Brass
Top Plate Stainless Steel
Dimensions (mm) W 700mm D 378mm H 157mm
Form of Ignition Piezo Ignition
Gas Consumption(LPG) L 4.8kW R 4.8kW



Mega Burner - Powerful flame (for both burners)

RI-522SC

WM: RM 189 EM: RM 199

Chilli Padi
HOT

1.9
kW



Burner Stainless Steel / Brass
Top Plate Enamel
Dimensions (mm) W 700mm D 378mm H 149mm
Form of Ignition Piezo Ignition
Gas Consumption(LPG) L 1.9kW R 1.9kW



Sun Burner  Stainless Steel Head

RI-511M

WM: RM 209 EM: RM 220

4.8
kW



Burner Stainless Steel / Brass
Top Plate Stainless Steel
Dimensions (mm) W 280mm D 380mm H 154mm
Form of Ignition Piezo Ignition
Gas Consumption(LPG) 4.8kW



Mega Burner - Powerful flame



Save More Than 10% Gas

*compared to min requirement set by local authority

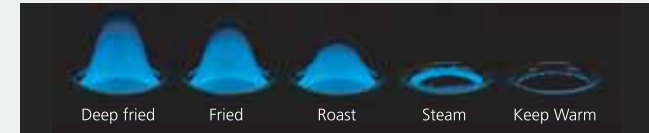

Detachable Top Plate

Our table top cooker comes with a detachable top plate. This feature allows for easy cleaning and maintenance.

8 Safety Features



High heating power and heat efficiency. Therefore saves gas and cooking time



Carbon monoxide (CO) gas from incomplete combustion is maintained at a low 0.04% - prevents risks to health

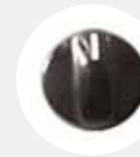

Special ABS plastic knob does not crack easily



Gas pipe is coated with special anti-rust paint



Enamel-coated pan support withstands heat up to 800°C



The highest-quality gas valve lasts for 60,000 usage cycles; its performance is guaranteed up to 5 years



Type 304 stainless steel burner with excellent anti-rust quality



Sturdy construction is able to support up to 50kg of total weight



PROMOTION PACKAGES



60cm/77lt Oven **RM 6,000**
RO-E6533T-EB ~~RM 7,500~~



60cm/77lt Oven **RM 4,480**
RO-E6523M-EB ~~RM 5,600~~



60cm/77lt Oven **RM 3,960**
RO-E6513M-ES ~~RM 4,950~~



60cm Oven **RM 2,597**
RO-E6208TA-EM ~~RM 3,246~~



60cm Oven **RM 2,298**
RO-E6206XA-EM ~~RM 2,872~~

suprema™
Brought to you by **Rinnai**

SUS 304 Kitchen Cold Tap
STB-03S STW-05S

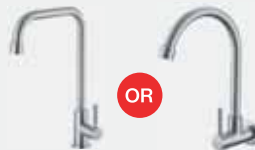

Brass Mixer **SUS 304 Mixer**
SMB-02B SMB-03S

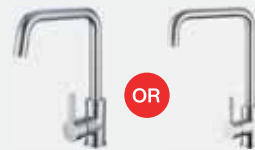

Brass Mixer
SMB-01B



SUS 304 3-Flow Mixer
S3FB-01S



SSP-1B-01
Overall Dimension 430mm x 410mm
Cut-out Dimension 410 x 390 (R90mm)
Bowl Dimension 400mm x 380mm
Bowl Depth 200mm

Only
RM 232

Only
RM 332

Only
RM 446

Only
RM 708



SSP-1B-07
Overall Dimension 582mm x 482mm
Cut-out Dimension 555 x 455(R40mm)
Bowl Dimension 480mm x 400mm
Bowl Depth 205mm

Only
RM 295

Only
RM 452

Only
RM 486

Only
RM 901



SSP-2B-08
Overall Dimension 820mm x 450mm
Cut-out Dimension 795 x 425(R10mm)
Bowl Dimension 420mm x 390mm (B)
310mm x 338mm (S)
Bowl Depth 205mm (B) 170mm (S)

Only
RM 388

Only
RM 557

Only
RM 594

Only
RM 1,007



SSH-1B-02
Overall Dimension 750mm x 440mm
Cut-out Dimension 730 x 420 (R10mm)
Bowl Dimension 710mm x 400mm
Bowl Depth 230mm

Only
RM 620

Only
RM 742

Only
RM 780

Only
RM 1,192

TECHNICAL DIAGRAM

BUILT-IN HOB INNER FLAME BURNER SERIES

RB-3CGT

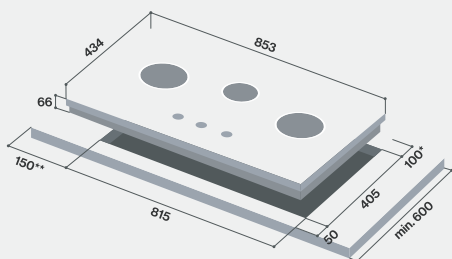

RB-2CGT

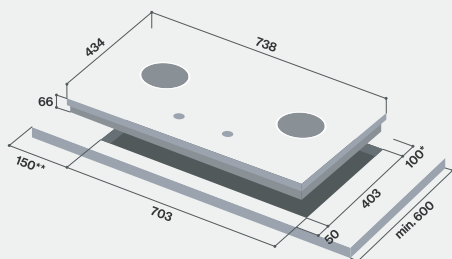

RB-3SI-C-S

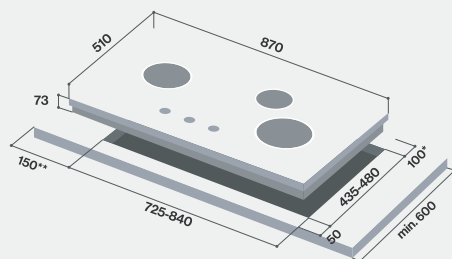

RB-2GIF

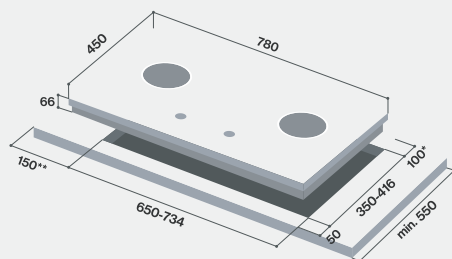

BUILT-IN HOB LOTUS FLAME BURNER SERIES

RB-L2620G-RM

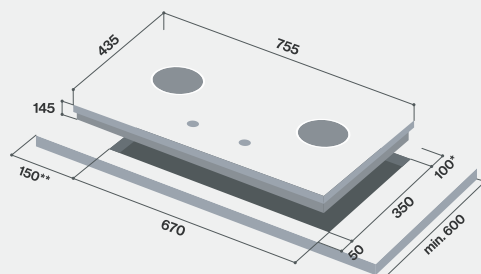

BUILT-IN HOB HYPER FLAME BURNER SERIES

RB-93UG

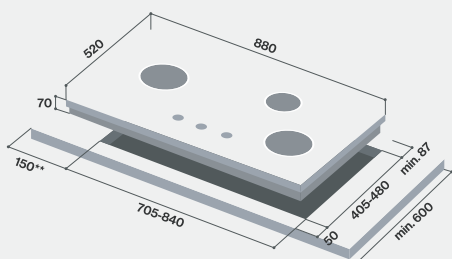

RB-72G

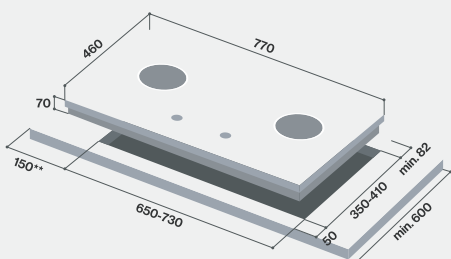

RB-92G

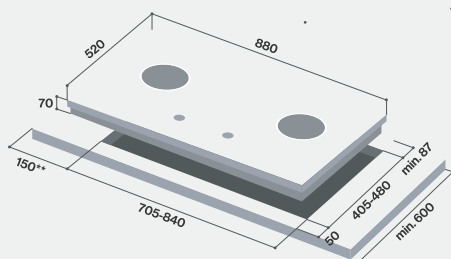

RB-72S

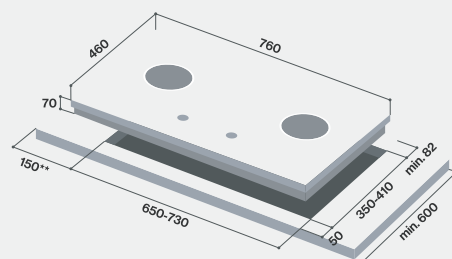

TECHNICAL DIAGRAM

BUILT-IN HOB FLEXI BURNER SERIES

RB-983G

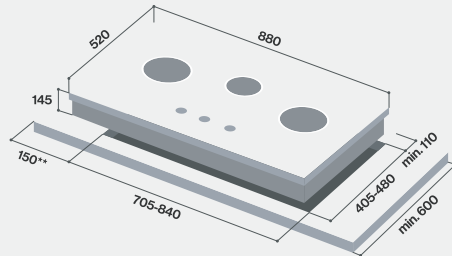

RB-982G

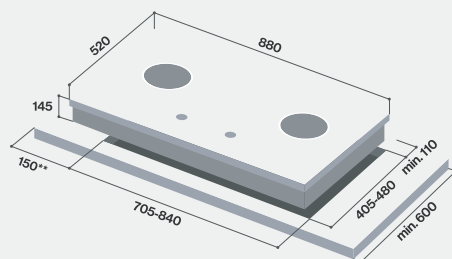

RB-782G

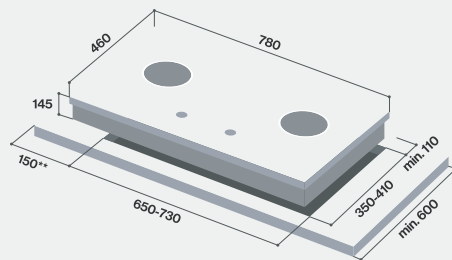

RB-38HS

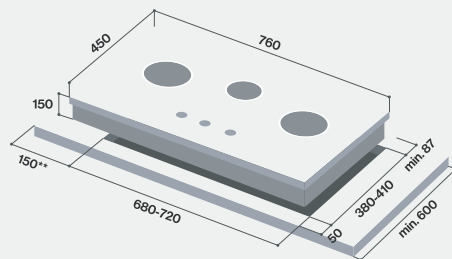

RB-27HS

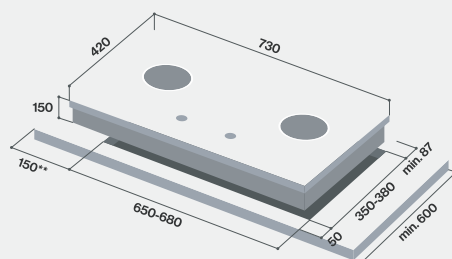

BUILT-IN HOB ECONOMY SERIES

RB-773G

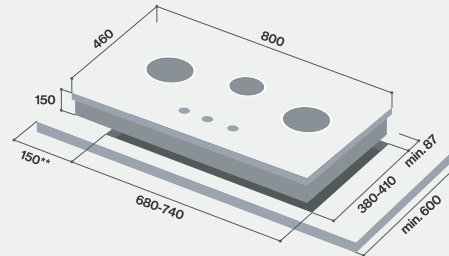

RB-772G

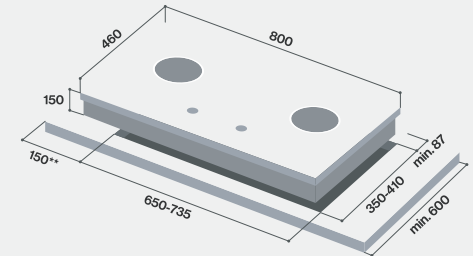

RB-773S

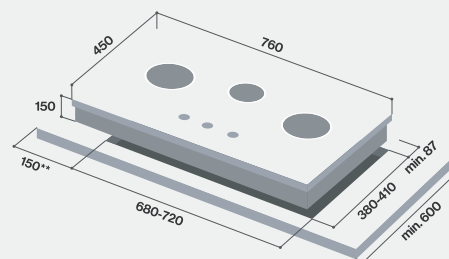

RB-772S

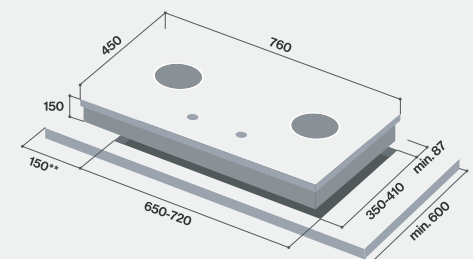

RB-3312S-GBC

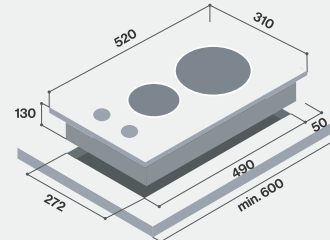

RB-3311S-GBC

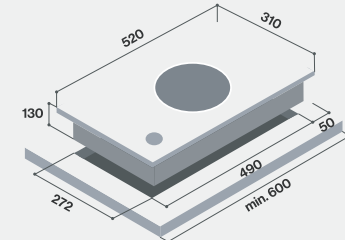

BUILT-IN HOB ELECTRIC HOB SERIES

RB-7152HEF-ZB

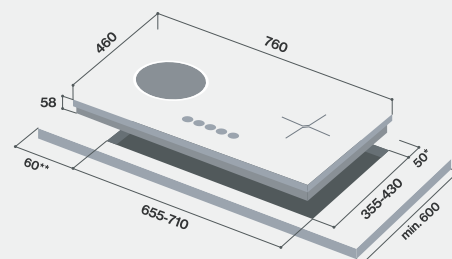

RB-7022HE-CB

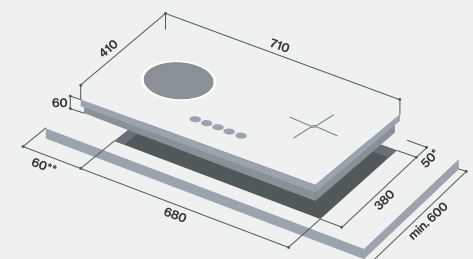

BUILT-IN HOB ELECTRIC HOB SERIES

RB-7013H-CB

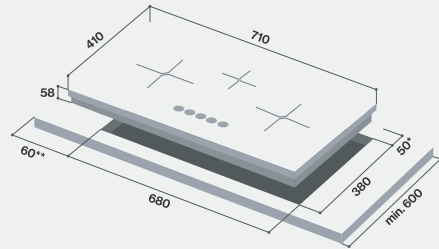

RB-7013E-CB

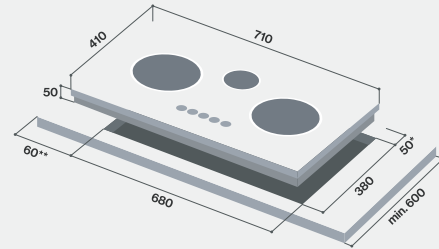

RB-6024H-CB

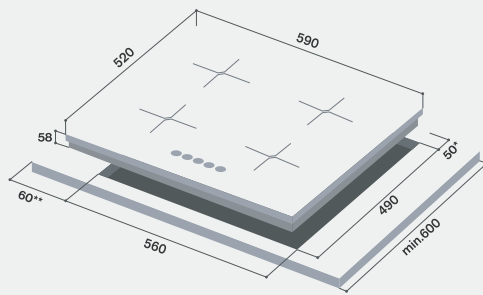

RB-6024E-CB

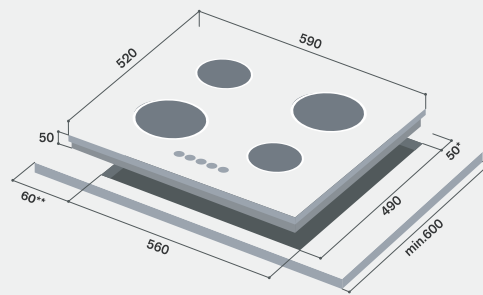

RB-5022H-CB

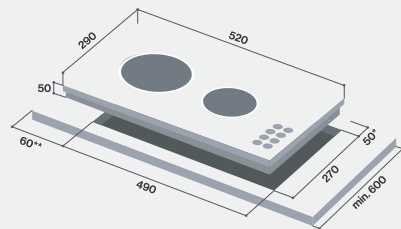

RB-5022E-CB

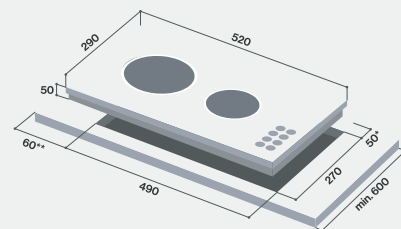

RB-3022H-CB

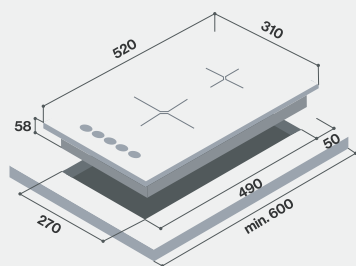

RB-3012E-CB

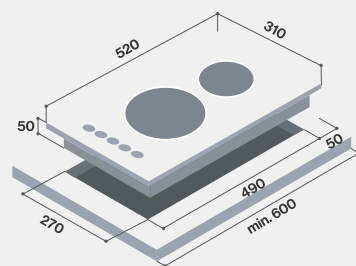

COOKER HOOD PLASMA SERIES

RH-D3154

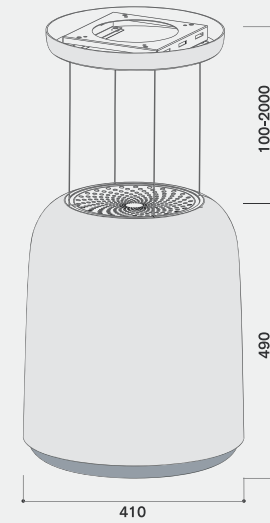

COOKER HOOD PRESTIGE SERIES

RH-L3619-PGW

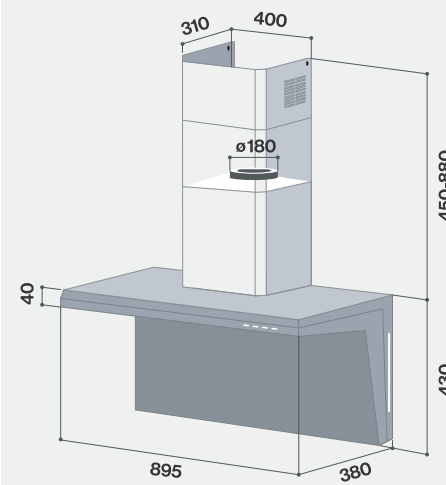

RH-L3719-PBW

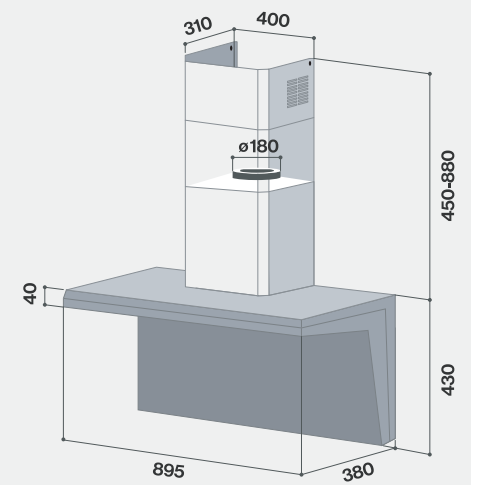

TECHNICAL DIAGRAM

COOKERHOOD ELITE SERIES

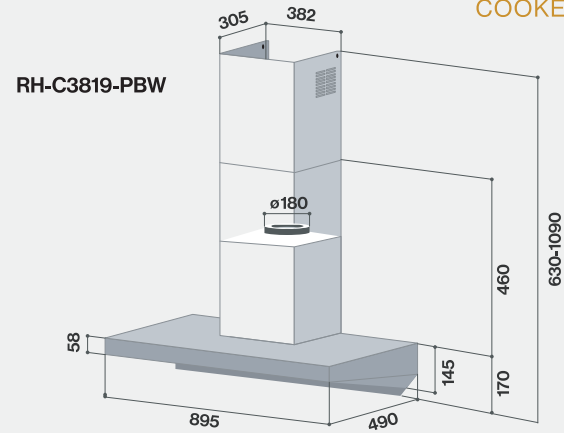

RH-C1059-PBW

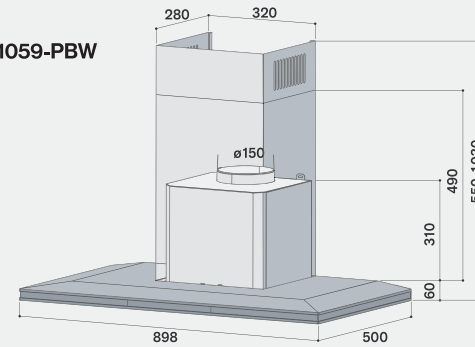

COOKERHOOD DESIGNER SERIES

RH-C91B-SSW

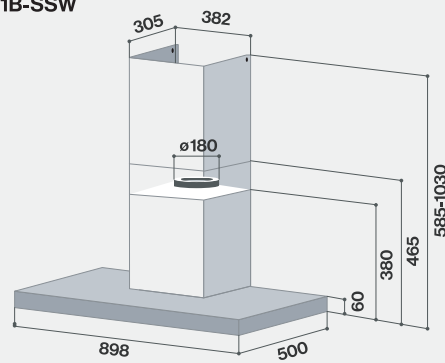

RH-C1159-PBW

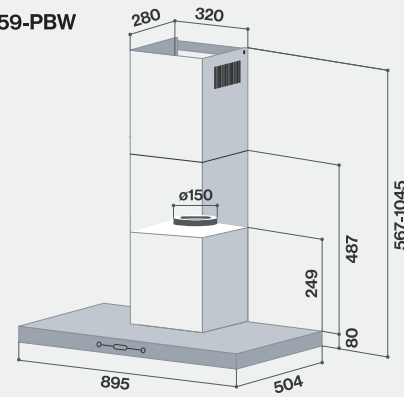

RH-KT2959-GBV

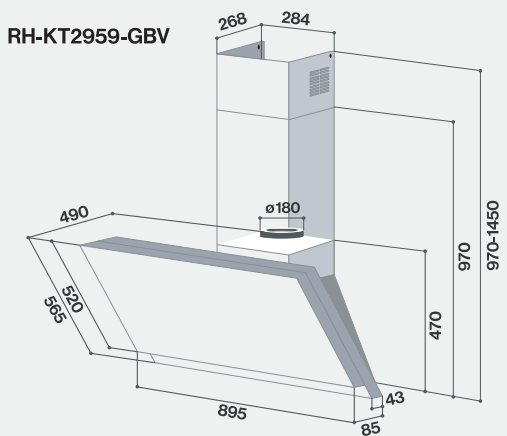

COOKERHOOD CHIMNEY SERIES

RH-C1119-GCW

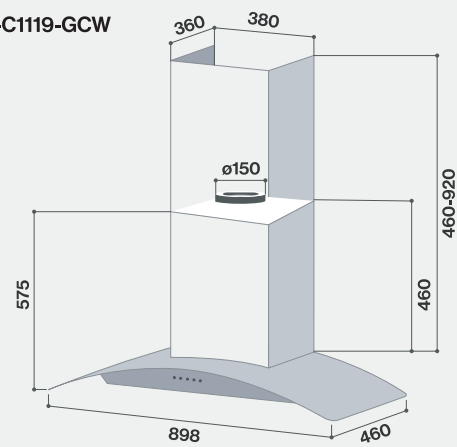

RH-C95F-SSVR

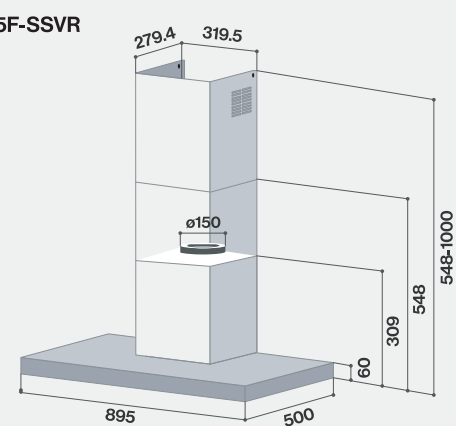

COOKER HOOD SLIM SERIES

RH-S3059-PBW

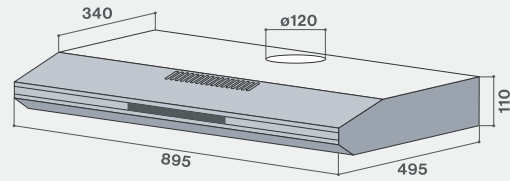

RH-S259-SSV-T/SSR-T

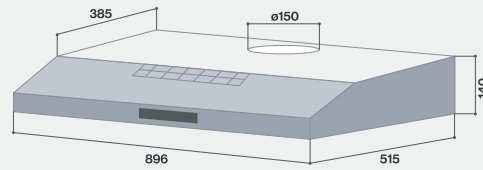

RH-S95A-SSVR

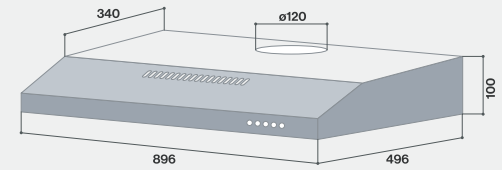

RH-S65A-SSVR

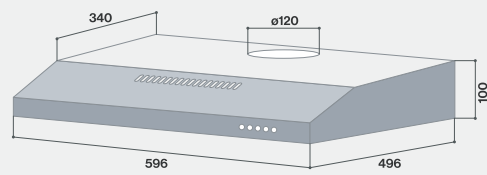

RH-TL95C-SSVR

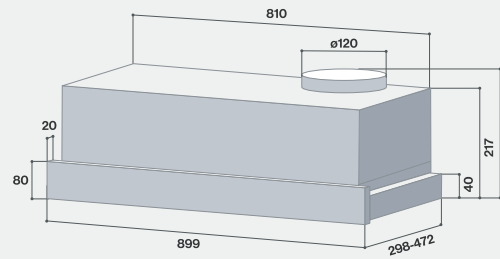

RH-TL65C-SSVR

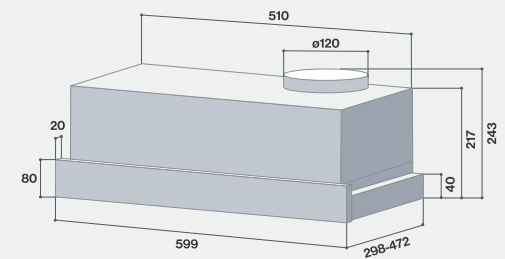

BUILT-IN OVEN ELECTRIC OVEN SERIES

RO-E6533T-EB / RO-E6523M-EB / RO-E6513M-ES

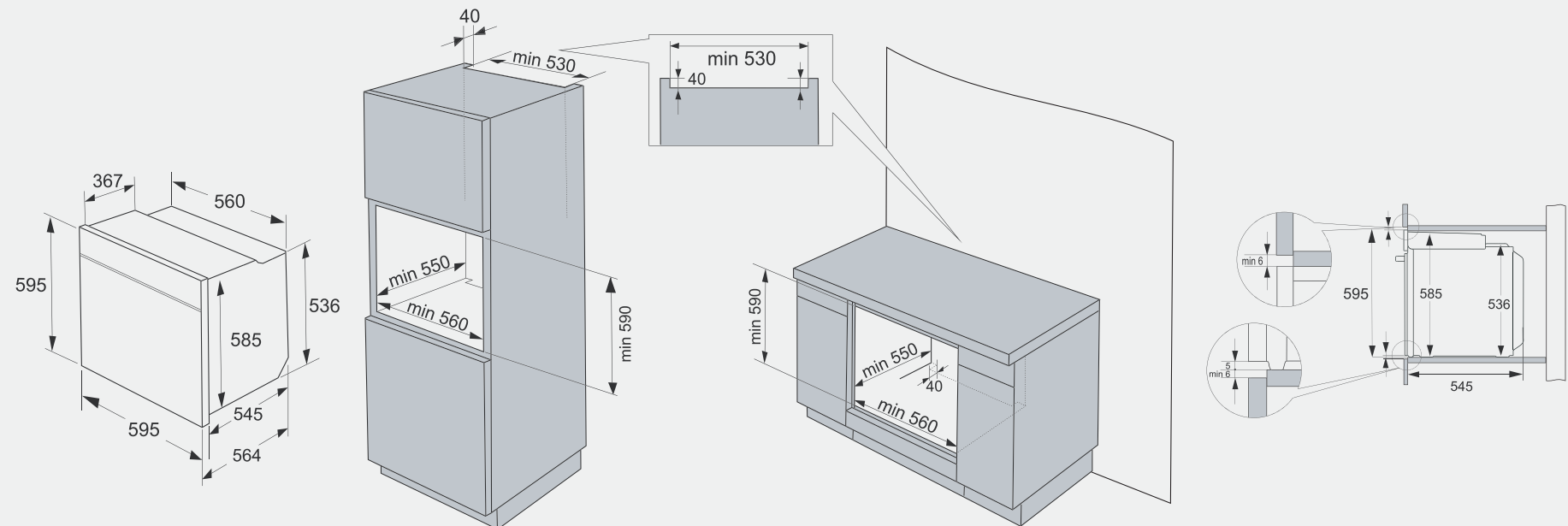

TECHNICAL DIAGRAM

BUILT-IN OVEN ELECTRIC OVEN SERIES

RO-E6208TA-EM

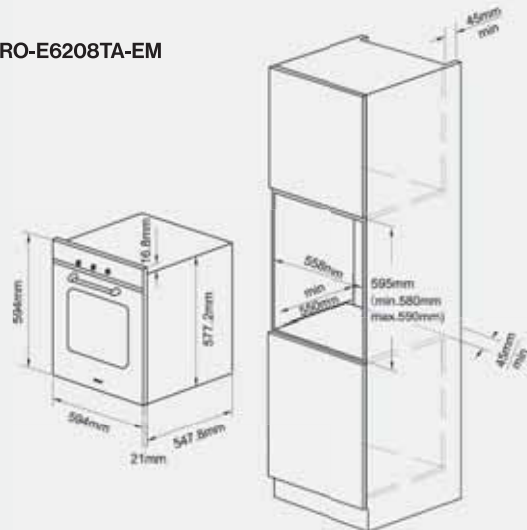

RO-E6206XA-EM

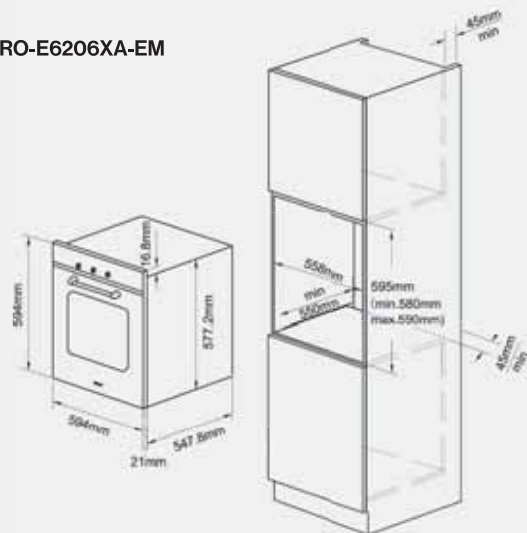
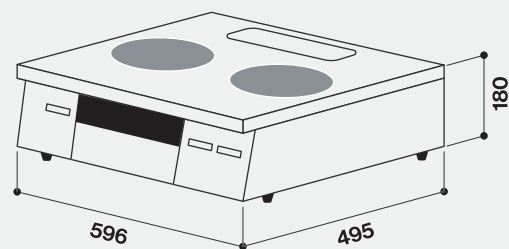
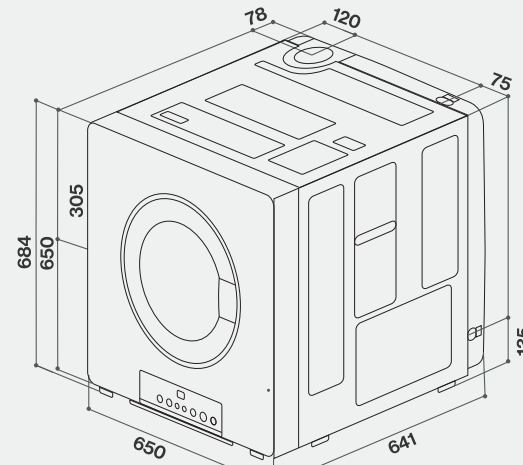

TABLE TOP COOKER WITH GRILL HOWARO C SERIES



GAS CLOTHES DRYER LAUNDRY SERIES

RDT-90-RM-S



RDT-62-RM-W

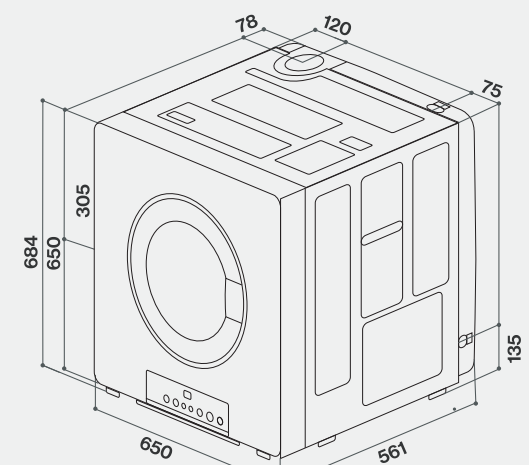

GAS WATER HEATER WATER HEATING SYSTEM SERIES

REU-A2626WD-GEN

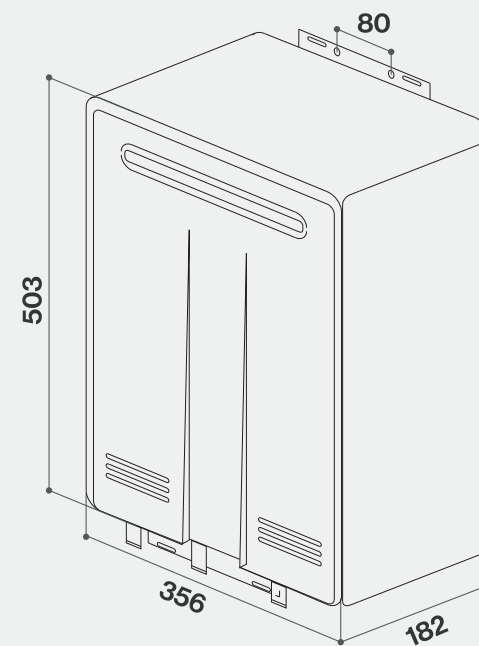

SINK SUPREMA KITCHEN SERIES

SSH-2B-04

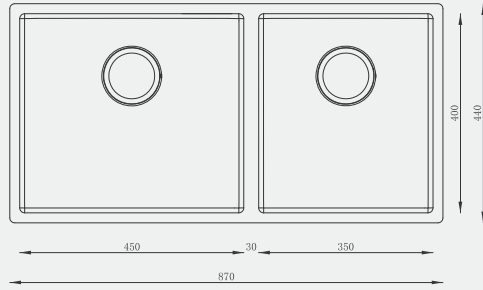

SSH-1B-02

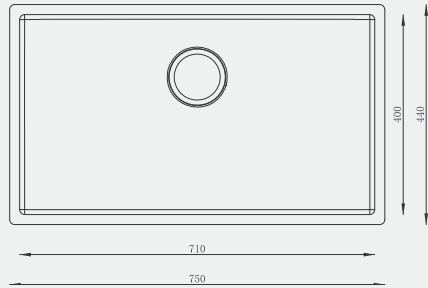

SSH-1B-01

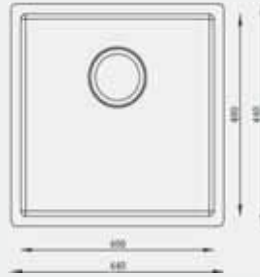

SSP-1B-04

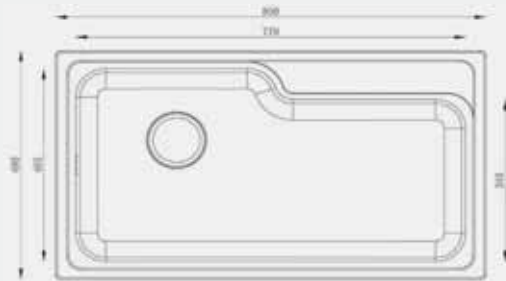

SSP-1B-03

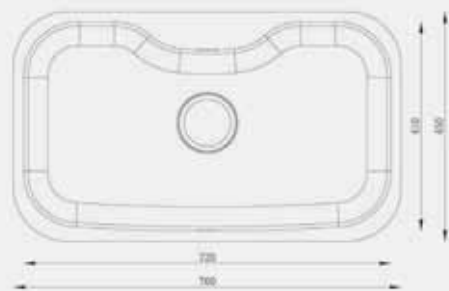

TAP SUPREMA KITCHEN SERIES

S3FB-01S

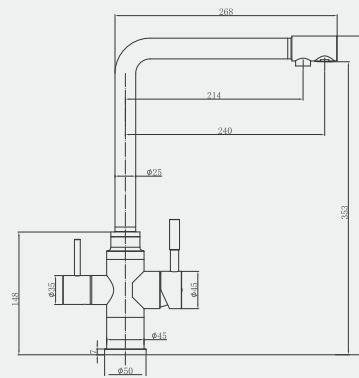

SMB-01B

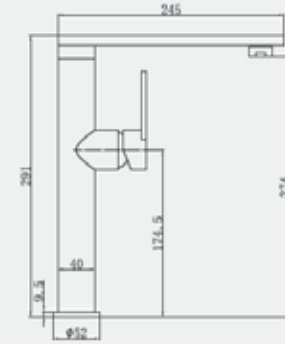

SMB-02B

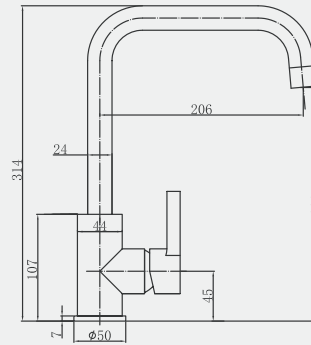

STB-03S

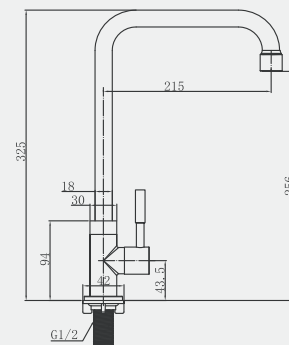

STW-04B

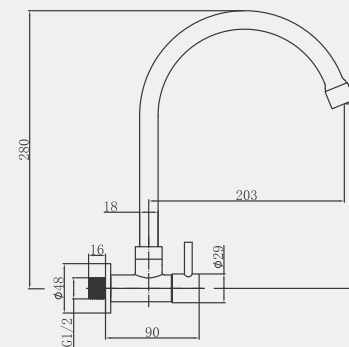

STW-05S

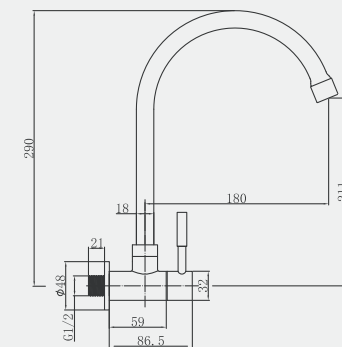

RINNAI WORLDWIDE

Rinnai UK Limited
Rinnai Services (MS) Co., Ltd.
Rinnai Italia S.r.l.
Rinnai Korea Corporation
Rinnai Corporation (Japan)
Shanghai Rinnai Co., Ltd
Rinnai Taiwan Corporation
Rinnai Hong Kong Ltd.
Rinnai Thailand Co., Ltd.
Rinnai Vietnam Co., Ltd.
Rinnai (Malaysia) Co., Ltd.
Rinnai Manufacturing Malaysia Co., Ltd.
Rinnai Holdings (Pacific) Pte. Ltd.
P.T. Rinnai Indonesia
Rinnai Australia Pty., Ltd.
Rinnai New Zealand Ltd.
Rinnai Canada Holdings Ltd.
Rinnai America Corporation
Rinnai Brazil Heating Technology Ltd.
Guangzhou Minghai Gas & Electrical Appliance Co., Ltd.

Rinnai (Malaysia) Sdn. Bhd. (197301002447)

Unit 2-8, Subplace Boulevard, Pusat Komersil Vestland,
No.6, Jalan Juruanalisis U1/35, Seksyen U1,
40150 Shah Alam, Selangor, Malaysia.
Fax: +603 5038 8905

Toll Free: 1800 88 8180

   [rinnaimalaysia](https://www.rinnaimalaysia.com)

enquiries@rinnai.com.my



www.rinnai.com.my



Full Catalogue

Dealer: