

Model Name:
RDT-90-RM-S

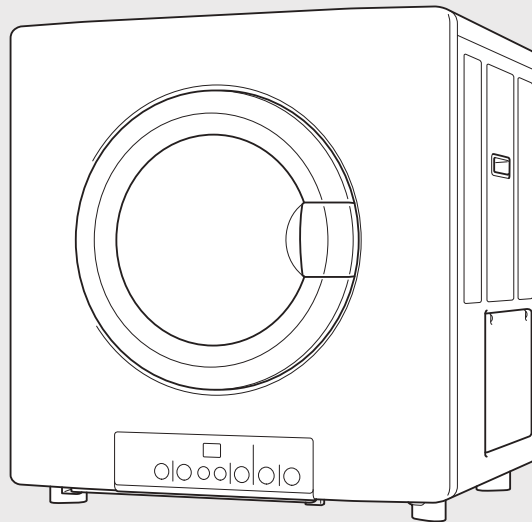

Thank you for buying this Gas Clothes Dryer.

Read This Document Thoroughly to Ensure Safe Use

- Before you use this dryer, thoroughly read these Operating Instructions to ensure safe and correct use.

Gas Clothes Dryer

Operating Instructions

Rinnai

Drying Is Now a Joy to Do and Feel!

LARGE 9 kg LOADS OF CLOTHES ALSO CAN BE DRIED

- Leave large loads that have been batch washed up to the drier to dry. You can dry clothes easily in a single operation by the THICK course.



QUICK DRYING

- You can dry clothes quickly when you are hurried in the morning or you want to wash your clothes in as short a time as possible after returning home.

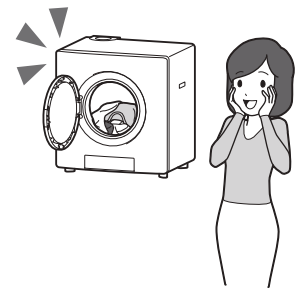

POWERFUL WARM AIR REDUCES THE MUSTY ODOR OF HALF-DRIED CLOTHES!

- Laundry that is left to dry indoors may not dry properly and can be left with a musty odor. Warm air inhibits the growth of odor-causing *Moraxella* bacteria (See Note).*1 It even takes care of odors that cannot be removed by drying outside or disinfecting with sunlight.

Note: A type of bacteria that exists in various places in the home. It feeds on remaining proteins, etc., and multiplies, causing a foul rag-like odor.



SELF-CLEAN COURSE, FOR TO STERILIZE DRUM

- Before drying, the inside of the drum is sterilized with warm air of 80°C or higher.*2 This function is useful if you have used the equipment to dry items other than clothes and you want to clean the inside of the drum before using it again.

ECO COURSE, FOR MORE ECONOMICAL DRYING

- This is the perfect course for those who want to save on gas costs, even though the drying time is longer. With this course, clothes are first dried using the air blowing operation, and are then finished up using the warm air operation.

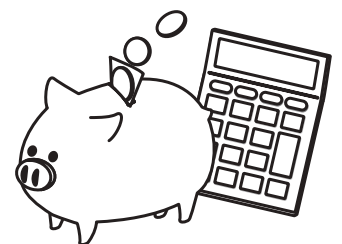

*1, *2 As tested by the School of Pharmacy, Aichi Gakuin University

FOUR COURSES TO CHOOSE FROM

1. GENERAL course

For drying 9 kg of clothes such as underwear and shirts

2. THICK course

For drying 9 kg of thick clothes

3. ECO course

Recommended when you want to save on gas costs even if drying time is longer than GENERAL course.

4. SHEET/BLANKET course

For drying sheets, blankets, and other items that roll up and are hard to dry

EASY FILTER REMOVAL

- The filter can be easily removed with your fingers, which makes maintenance and cleaning easy to do.

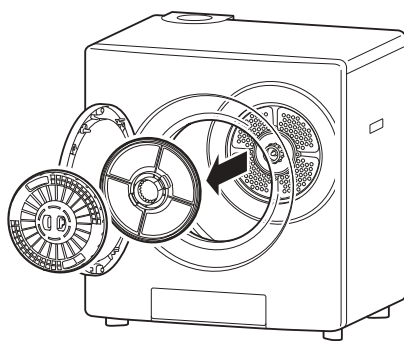

EXCELLENT DURABILITY ALLOWING USE IN BARBERSHOPS, HAIR SALONS AND OTHER FACILITIES

Table of contents

To Ensure Safe Use

Safety Precautions (Be Sure to Follow These Precautions)	3
Safety Precautions (Installation)	5
Safety Precautions (Actual Use)	9
Safety Precautions (Notes)	15

Introduction

Names & Functions of Parts	19
Before Using the Equipment	23
Flow of Operations	23
Items You Must Not Dry	24

Operation



How to Select Courses	25
How to Use Drying Course Operation	27
How to Use Timer Operation	31
How to Use SELF-CLEAN Operation	33
Buzzer Functions	36
Advanced Operation	37

To Ensure Prolonged Operation











Daily Inspection and Maintenance	39
Maintenance Methods	40
Troubleshooting	43
Displayed Messages	45
Specifications and Dimensional Diagram	49

Safety Precautions (Be Sure to Follow These Precautions)

- The following describes precautions that must be followed to ensure the same use of the product and to prevent injury to the customer or others and damage to property.
- Fully understand the meaning of the following symbols before reading this document.

 Danger	This symbol indicates that ignoring the accompanying explanation and mishandling the product might result in death or serious injury or a fire hazard.
 Warning	This symbol indicates that ignoring the accompanying explanation and mishandling the product might result in death or serious injury or might cause the risk of fire.
 Caution	This symbol indicates that ignoring the accompanying explanation and mishandling the product might result in slight injury or might cause property damage.

- The meanings of pictograph symbols used in this manual are as follows.

 This pictograph symbol indicates a “prohibited action” that must not be done.	 Naked Flames Prohibited	 Disassembly Prohibited	 Wet Hands Prohibited	 Splashing With Water Prohibited
 This pictograph symbol indicates an “alert” for items you should be careful of.				
 This pictograph symbol indicates a “compulsory action” that you must do.	 Remove power plug from power outlet	 Ventilation required	 Be sure to connect ground lead	



Danger

This symbol indicates that ignoring the accompanying explanation and mishandling the product might result in death or serious injury or a fire hazard.

The following actions are prohibited when there is a gas leak:



Naked
Flames
Prohibited

- Never light a fire
- Do not turn electrical apparatus switches on or off
- Do not remove or insert power plugs
- Do not use telephones in the immediate area
- Do not use fire to find source of gas leak
- Do not press nearby door bells located on the same floor
- Do not reopen the gas valve until gas is no longer leaking

Flames or sparks might ignite the gas and cause an explosion.

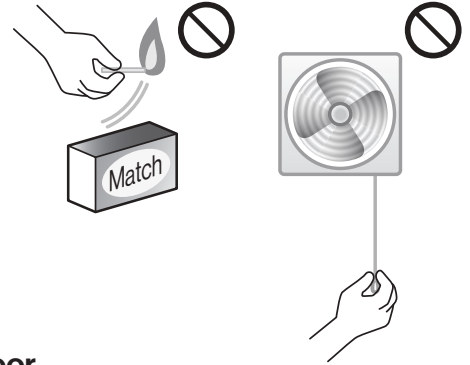

Use is prohibited during a gas leak



- If you notice a gas leak, immediately stop use of the product

1. Close the gas cock on the product and the gas cock on the meter.
In the case of gas cocks without a knob, remove the connector from the gas cock.
2. Open doors and windows to allow gas to escape to the outside.
3. Call the 24-hour Emergency Hotline from the nearest outside telephone.

Gas cock (example)

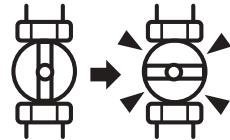

Close the gas valve!



Safety Precautions (Installation)



Warning

This symbol indicates that ignoring the accompanying explanation and mishandling the product might result in death or serious injury or might cause the risk of fire.

Remodeling/Disassembly Prohibited



Disassembly Prohibited

• Users must never use tools to install, move, disassemble, repair, or remodel the equipments themselves.

- Doing so may cause carbon monoxide poisoning or fire, and cause the equipment to malfunction.
- Installation, moving, disassembly, repair, or remodeling of the equipment requires highly special knowledge.

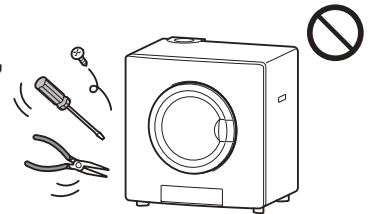

Checking gas and power supply used



• Use the equipment with only the gas type (gas group) and power supply (power voltage/frequency) indicated on the data plate on the equipment. Do not use with other gas types or power supplies.

- Do not use the equipment when gas and power supply used does not match the gas and power supply indicated on the data plate. Then, incomplete combustion may cause carbon monoxide poisoning, or cause explosive ignition or equipment to malfunction.

Data plate (example)

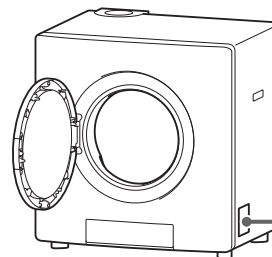
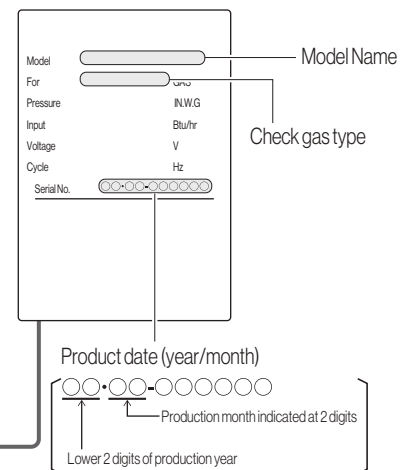

Fire Prevention Equipment in Surrounding Area



• Allow sufficient space between the equipment and flammable objects such as furniture, walls and shelves.

- Allow at least the standard installation dimensions (in figure at right) in consideration of maintenance management and works. Failure to do so might result in fire or the equipment overheating and cause burns.

{ Standard installation dimensions }

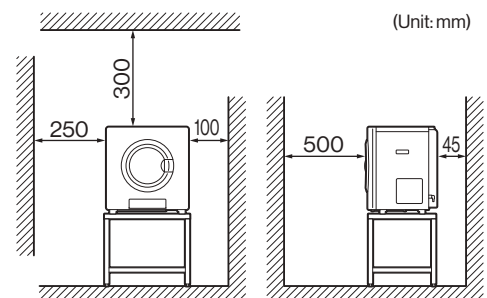

Installation Site



Splashing
With Water
Prohibited

- Do not install the equipment in hot and humid locations such as bathrooms or in locations (excluding veranda installations) that are exposed to wind and rain.

Doing so may cause a short circuit, and result in electric shock or fire. This may also cause the equipment to malfunction.



- When using the equipment outdoors, such as on a veranda or in the space under the eaves, attach a roof like a sunshade above the equipment, and install the optional discharge top.

Water or rainfall directly splashing the equipment may cause a short circuit, and result in electric shock or fire. This may also cause the equipment to malfunction.

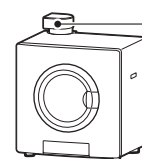

Discharge top
(option)

Ventilation



- If no humidity duct (venting hose) is fitting, the room shall be provided with air vents which communicate directly with outside air and are sized in accordance with the following table:

Room Volume (m ³)	<5	5–10	>10
Minimum permanent opening free area (cm ²)	100	50*	Nil

* If the room has a door which opens directly to outside, no permanent opening is required.

- If humidity duct is connected, air vent is not necessary.

Power cord



- Do not pass the power cord under or allow it to come in contact with the equipment.

Doing so might damage the power cord, and result in electric shock or fire.

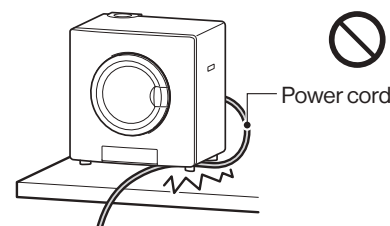

Power cord

Safety Precautions (Installation)



Caution

This symbol indicates that ignoring the accompanying explanation and mishandling the product might result in slight injury or might cause property damage.

Installation Site



- **Do not use the equipment where there is the risk of objects falling such as under shelves.**

Falling objects may cause a fire or equipment to malfunction.



- **Do not use the equipment at locations where lots of steam, noise, etc. from the discharge top might annoy neighbors.**

This may cause condensation or noise.

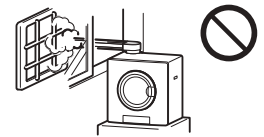

- **Do not use the equipment at locations where there is lots of cotton dust.**

This may cause the equipment to malfunction.



- **Do not direct discharged exhaust gas or steam from the discharge top at pets, potted plants, etc.**

Doing so might result in the pets death or cause plants to wither.

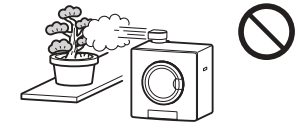

- **When installing the equipment in a barbershop, hair salon or dry cleaning store, ensure an air intake passage is in place to avoid**

The corrosive gas is hair spray, cleaning solvents, ammonia, chlorine, etc.

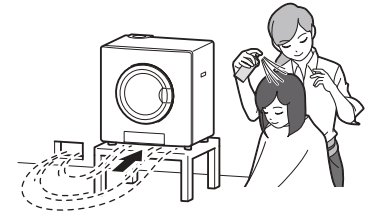

- **Ask the store of purchase or a contractor to install and move the equipment and perform incidental work, and get them to install the equipment properly at a safe location.**

Defective installation performed by users themselves might result in fire, carbon monoxide poisoning or gas leaks.

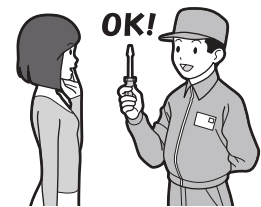

- **When using the equipment placed on an exclusive stand, install the exclusive stand immediately in front of a wall, and join the exclusive stand to a wall or pillar by chains (provided with the exclusive stand). Also, secure the equipment by screwing it onto the exclusive stand.**

If there is no wall behind the equipment, or the chains are not joined sufficiently or the equipment is not sufficiently screwed onto the exclusive stand, the equipment might tip over and cause an injury.

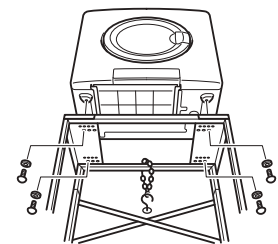



- Use the equipment at a flat, stable and sturdy location, a location that can sufficiently withstand the weight of the dryer, and a location that is not subject to excessive noise or vibration. Using a spirit level, make sure that the equipment is level.

If the equipment is used at an unstable or tilted location, the safety interlock might not function properly or the equipment might tip over and cause an injury. Also, if the equipment is used tilted towards the front, the front door might open with force and cause an injury.

This might also damage the building or cause noise.

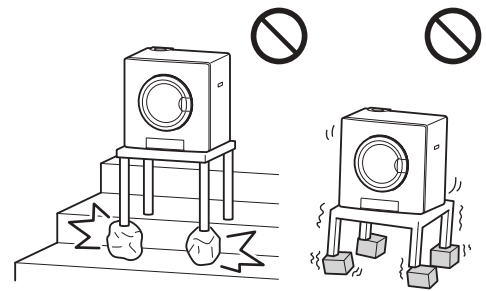

Discharge of Humidity



- Do not directly connect the discharge tube to a ventilator, etc.

Insufficient air flow from the ventilator might block air discharge and stop the equipment to stop, and cause humidity to leak or mold to form.

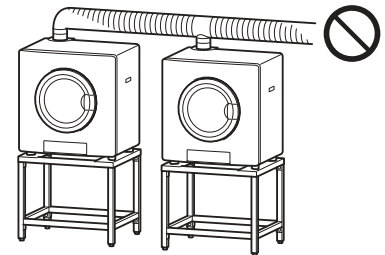

- For optimal function of the machine, the length of dia. 80 mm humidity duct is recommended not to exceed 8 m and 2 bend. Reduce 2 m when adding one bend.
- Maximum allowable length is 12 m and 1 bend (equivalent to 8 m and 2 bends) for dia. 80 mm humidity duct. Reduce 2 m when adding one bend. Under this condition, the machine still functions safely and normally, however, the drying time and the frequency of lint filter cleaning may increase.
- According to the real situation, in case it is not necessary to install the humidity duct, please use the exhaust humidity top to install at exhaust outlet.

Safety Precautions (Actual Use)



Warning

This symbol indicates that ignoring the accompanying explanation and mishandling the product might result in death or serious injury or might cause the risk of fire.

Fire Prevention



- **Do not use objects that might ignite near the equipment.**

Do not place or use objects, etc. such as aerosols, gasoline or benzene that might ignite. Doing so may cause an explosion or ignition which will result in a fire.

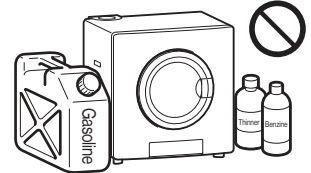

- **Never dry clothes made of polypropylene fiber or clothes with the following oils on them after they have been washed.**

When temperature rises, clothes made of polypropylene fiber may ignite spontaneously. Also, oil, etc. is hard to remove completely even by washing. So, heat generated by oil combustion may cause it to ignite spontaneously or catch fire.

- Edible oil, machine oil, animal oils
- Dry-cleaning fluids, perm solutions
- Beauty treatment oils (body oils, beauty salon oils, etc.)
- Benzene, paint thinner, gasoline
- Resins (cellulose type)



- **Do not stop operation by removing the power plug.**

This may cause the equipment to overheat. Oil, etc. adhering to clothes also may cause spontaneous combustion due to heat generated by oil combustion.



- **Make sure that there are no flammable objects such as cigarette lighters or matches in your pocket.**

These may cause a fire.

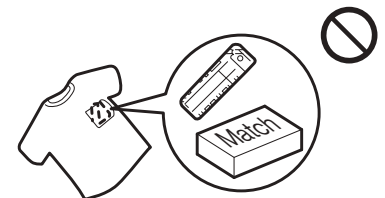

- **Remove clothes after drying ends. In particular, be sure to remove clothes immediately when the equipment has been stopped immediately before or after drying ends.**

Oil, etc. adhering to clothes may cause spontaneous combustion from heat generated by oil combustion if clothing is left for a long period of time.

When Using the Gas Dryer



- **Do not allow unaccompanied small children to use the gas dryer by themselves, and do not use the gas dryer within the reach of infants.**

Doing so might cause burns, electric shock or injury.

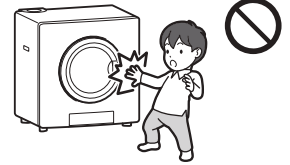

- **When opening or closing the front door, do not bring your hand or fingers close to the door hinge.**

Doing so might result in your hand or fingers being nipped and cause an injury.

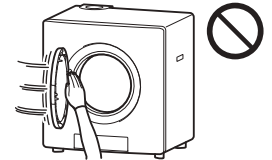

- **Before opening or closing the front door, make sure that there are no people or obstacles in the immediate surrounding area, and gently open or close with your hand on the door.**

Opening or closing the door with excessive force may cause an injury, damage the equipment or cause it to tip over. The dead weight of the front door or the affect of wind may cause the front door to open with force and cause an injury.

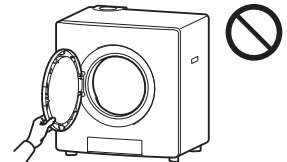

Safety Precautions (Actual Use)



Wet Hands
Prohibited

Power Cord and Plug

- **Do not remove or insert with wet hands.**

This may cause electric shock or injury.



- **Do not extend power cords by cutting them.**

Install the equipment within reach of the power cord to the power outlet.

This may cause electric shock or injury.

- **Do not connect damaged power cords or plugs to power outlets or use power outlets with loose connections.**

Doing so may cause an electric shock or generate heat, and result in fire.

- **Do not remove the power plug by pulling the power cord.**

When removing the power plug, do not pull it by its power cord but remove it by holding the power plug.

Tugging the power cord may damage it, which may result in an electric shock, short circuit or fire or cause the equipment to malfunction.

- **Do not use the equipment above the rating of the power outlet or wiring appliance. Use the equipment with only a 240 V alternating current (AC) power supply. Do not use with other power supplies.**

When the designated rating is exceeded, for example, by using a multi-outlet extension cord, this may generate heat, and result in fire.

- **Do not exert unnecessary force or place heavy objects on the power cord, or use the power cord in a bundled state.**

This may cause electric shock or injury.



- **Firmly insert power plugs into power outlets as far as they can go.**

Failure to do so may cause an electric shock or generate heat, and result in fire.

- **Periodically remove dust, etc. from power plugs.**

Remove the power plug and wipe clean with a dry cloth. Accumulation of dust on the power plug may cause power insulation resulting from moisture, etc. or cause fire.



Warning

This symbol indicates that ignoring the accompanying explanation and mishandling the product might result in death or serious injury or might cause the risk of fire.

Remedies for Abnormal Operation



- **If operation is abnormal, immediately stop use of the equipment, close the gas cock, and remove clothes.**

1. If gas does not light, or if you sense abnormal combustion or temperature, smell abnormal odor, or hear abnormal noise during operation, immediately perform steps 1 to 4 in the figure below. Leaving the equipment in this state may cause an explosion or a fire.

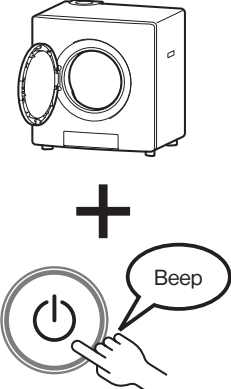
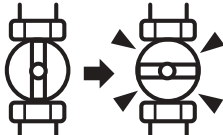
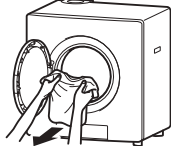
1. Press the "Start / Pause" switch.	2. Open the front door and hold down the "Power" switch until you hear a beep.	3. Close the gas valve.	4. Remove the clothes.
	 <p>Press the switch with the front door open until you hear a beep.</p>		

2. If you sense that operation is abnormal, follow instructions given in "Troubleshooting" and "Displayed Messages." (See pages 43 to 48.)
3. If even the above steps do not remedy the problem, immediately stop use of the equipment, contact the store of purchase or call Customer Services Hotline.

- **In the event of an earthquake, fire or similar event, immediately stop use of the equipment, and close the gas cock and gas cock on the meter.**

(In the case of gas cocks without a knob, remove the connector from the gas cock.)

Safety Precautions (Actual Use)

Ventilation



Ventilation
Required

- **During use, ventilate the room, for example, by opening the window.**

Not ventilating the room will cause incomplete combustion which might result in carbon monoxide poisoning.



Caution

This symbol indicates that ignoring the accompanying explanation and mishandling the product might result in slight injury or might cause property damage.

When Using the Gas Dryer



Splashing
With Water
Prohibited

- **Do not splash the body or drum with water or wash with water.**

Doing so may cause an electric shock or a short circuit which will result in a fire.

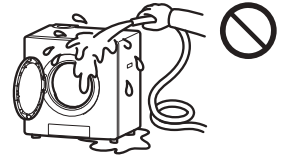

- **Do not block the air inlet with a curtain or similar heavy material or clothing.**

This will cause incomplete combustion or the equipment to overheat which will result in burns or equipment malfunction.

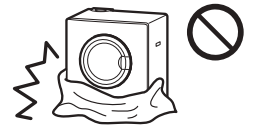

- **Do not use the equipment at locations that are susceptible to humidity.**

Clothes, etc. are sometimes damaged by the humidity contained in the discharged exhaust gas.

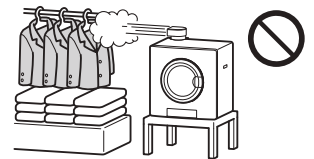

- **Make sure that the front door is closed.**

If the equipment is operated with the front door open, this may result in the equipment malfunctioning or clothes flying out.

- **Before putting clothes in the dryer, check clothes for metal powder or metal pieces attached or in pockets.**

These may cause burns or equipment malfunction.

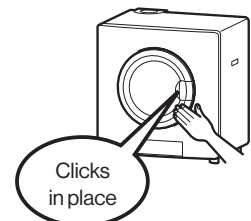

Fire Prevention, Be Careful of Burns



- **Do not remove clothes during operation.**

The inside of the drum, front door and clothes are hot. Do not touch these directly with your hands. Doing so might cause burns. Wait for operation to end before removing clothes.

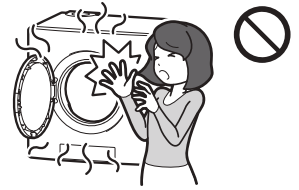

- **Use the equipment only for drying clothes (including fabric footwear). Do not use it for any other purpose.**

This may cause a fire.

- **Do not cover the top of the dryer with a blanket or clothes.**

This may cause a fire. This may also deform the equipment or cause the equipment to malfunction.

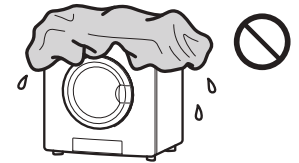

- **If the equipment stops abnormally during drying, allow the temperature inside of the drum to drop before removing clothes.**

Removing clothes immediately may cause burns.

Power Cord and Plug



Remove
Power Plug
from Power
Outlet

- **Before inspecting and performing maintenance on the equipment, be sure to remove the power plug.**

Failure to do so may cause electric shock or injury.

Safety Precautions (Notes)

Notes

Checks Before Use

- Remove paper padding or packing material from each of the parts on the equipment, and check the contents of the package and accessories against the Packing List.
(See page 20.)

Checking the Installation Site

- Do not install the equipment on electric carpets or hot water heating mats. The weight of the equipment may cause electric carpets or hot water heating mats to malfunction. Also, the heat from the electric carpets or hot water heating mats may disrupt equipment control.
- This equipment can be used up to an elevation of 1000 meters above sea. If it is used above this elevation, this may cause defective lighting.

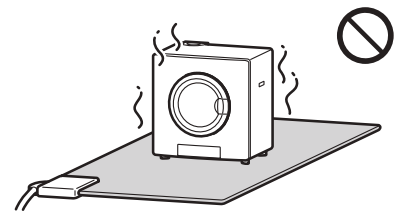

Cautions During Thunderstorms

- When a thunderstorm starts up, promptly stop operation, and remove the power plug from the power outlet. Lightning from thunderstorms causes an overcurrent to flow momentarily which may damage electronic components.

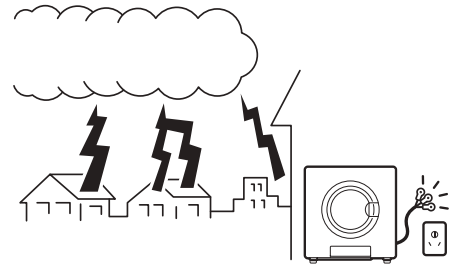

Handling Clothes

- Do not operate the equipment with clothes trapped in the front door. Doing so is dangerous as it interferes with drum rotation.
- Do not put too many clothes into the equipment. This may cause uneven drying, damage clothes or cause equipment malfunction. When the drum is entirely filled with spun-dried clothes, dry the clothes in two separate batches.
- Do not leave moist washed clothes or put clothes containing seawater inside the equipment. Moisture or seawater may cause the equipment to rust or malfunction.
- Do not dry starched clothes. Starch may block the filter. For starching clothes, use “spray starch” after drying the clothes.

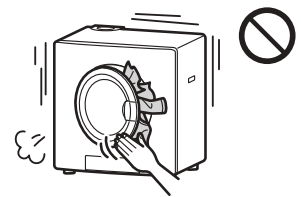
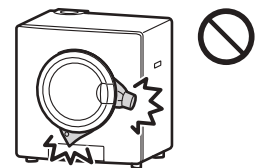

Accessories & Options

- Use only the accessories provided with the equipment or the designated options. Do not use other accessories or options. Doing so may cause the equipment to malfunction or cause unexpected accidents.

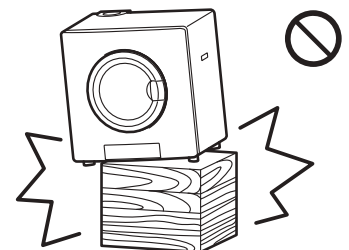

Safety Precautions (Notes)

Handling the Equipment

- Do not hang down from or hang heavy objects on the equipment or front door. Doing so may cause injury or burns. This may also cause the equipment to tip over, cause gas leaks or incomplete combustion as a result of equipment deformation, or cause other equipment malfunctions.
- Do not block or put things inside the discharge duct. Doing so may increase the drying time, or cause abnormal equipment overheating or equipment malfunction.
- If there is a power outage during use or operation is stopped by removing the power plug by mistake, repeat equipment operation after power is resumed.
- Do not use aerosols containing silicon such as hair spray or antiperspirant spray near the equipment. White powder from the silicon sometimes sticks to the equipment.
- Take care not to bump your head on the front door or exclusive stand when taking laundry from the washing machine.
- Please exercise caution around the front door, which contains protruding parts that press the switch to detect whether the door is open or closed.

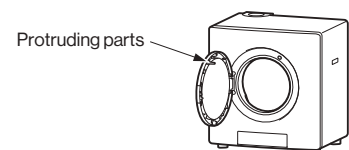
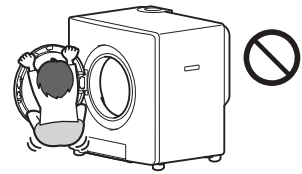

Drying Cautions

- Clothes must be sufficiently spun-dried in a washing machine before they are dried in this equipment. Insufficient spin-drying may increase the drying time, or cause abnormal equipment malfunction or a short circuit.
- If chlorine-based bleaching agents have been used in washing the clothes, thoroughly rinse before drying. Chlorine remaining in the clothes may cause the equipment to malfunction.
- Do not put wet dripping clothes in the equipment. Doing so might cause electric shock.
- Do not open the front door or put in extra clothes midway during drying. This may cause uneven drying.



Checking Ignition and Forgetting to Turn Pilot Light Out

- Check ignition during use, and check that the pilot light is out after use.
- Before going out or going to bed, check to see if you have not forgotten to turn the pilot light out.
- After use, be sure to check that the pilot light is out. Before you go out or plan not to use the equipment for a long time, be sure to close the gas cock. (In the case of gas cocks without a knob, remove the connector from the gas cock.)

Names & Functions of Parts

Figure shows a left-opening door.

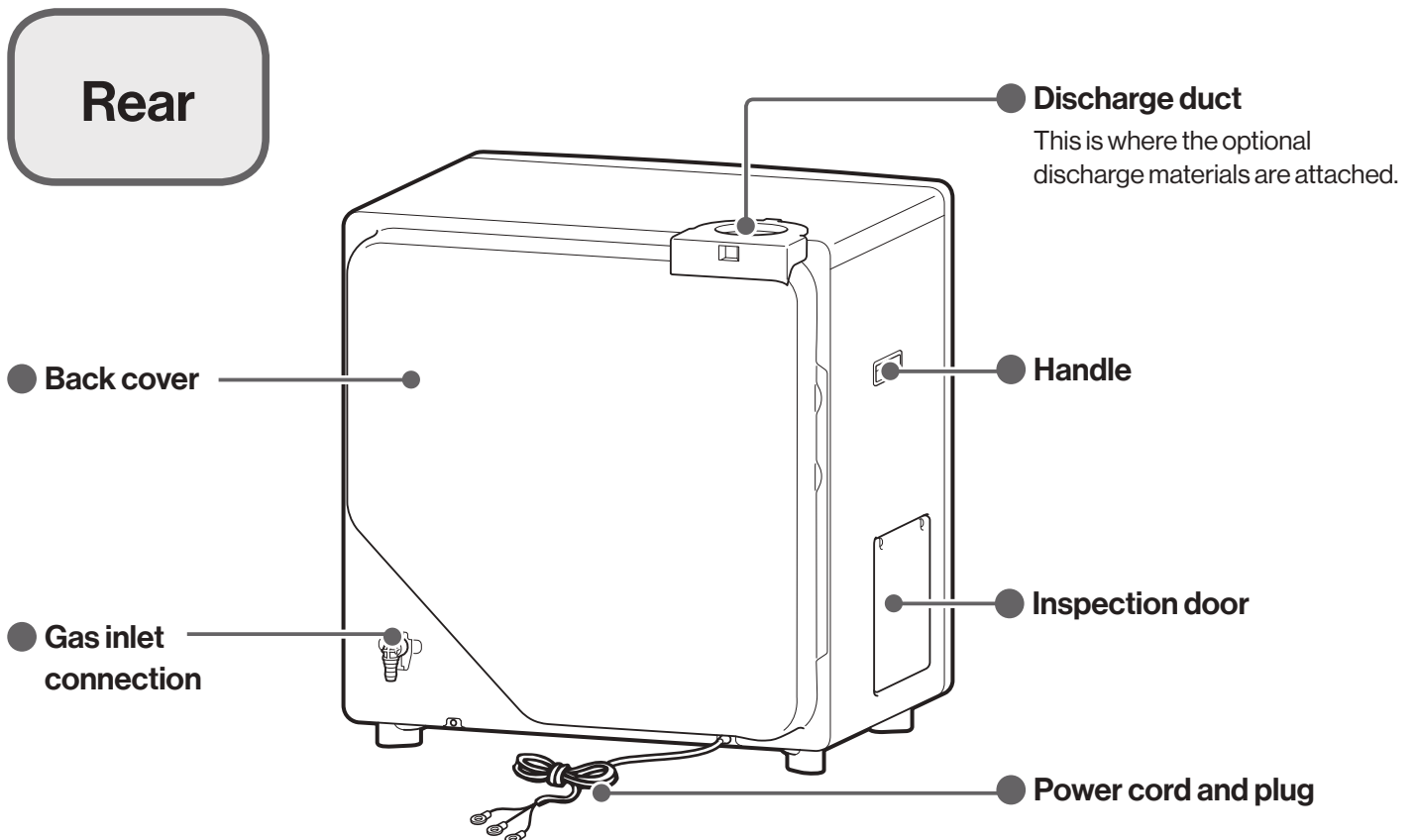
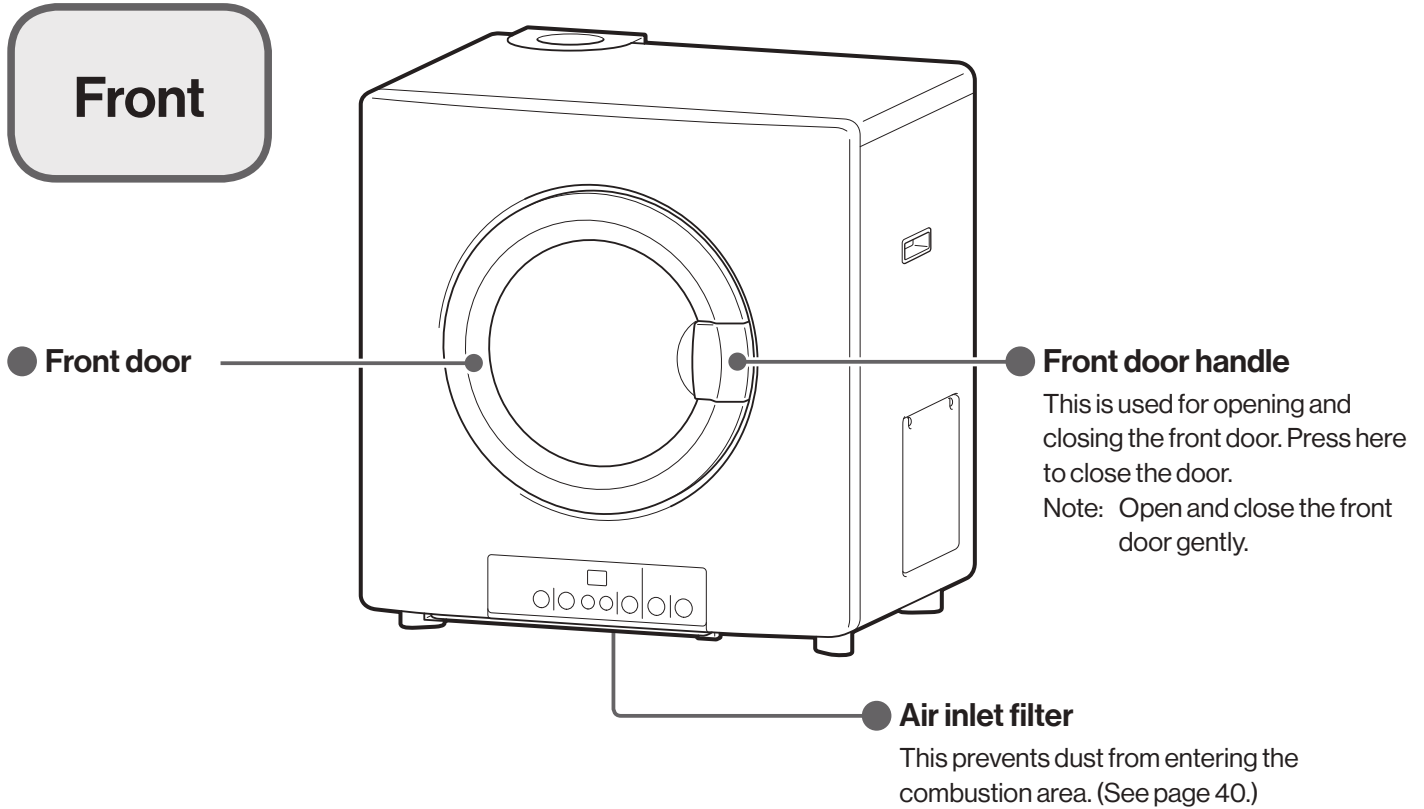
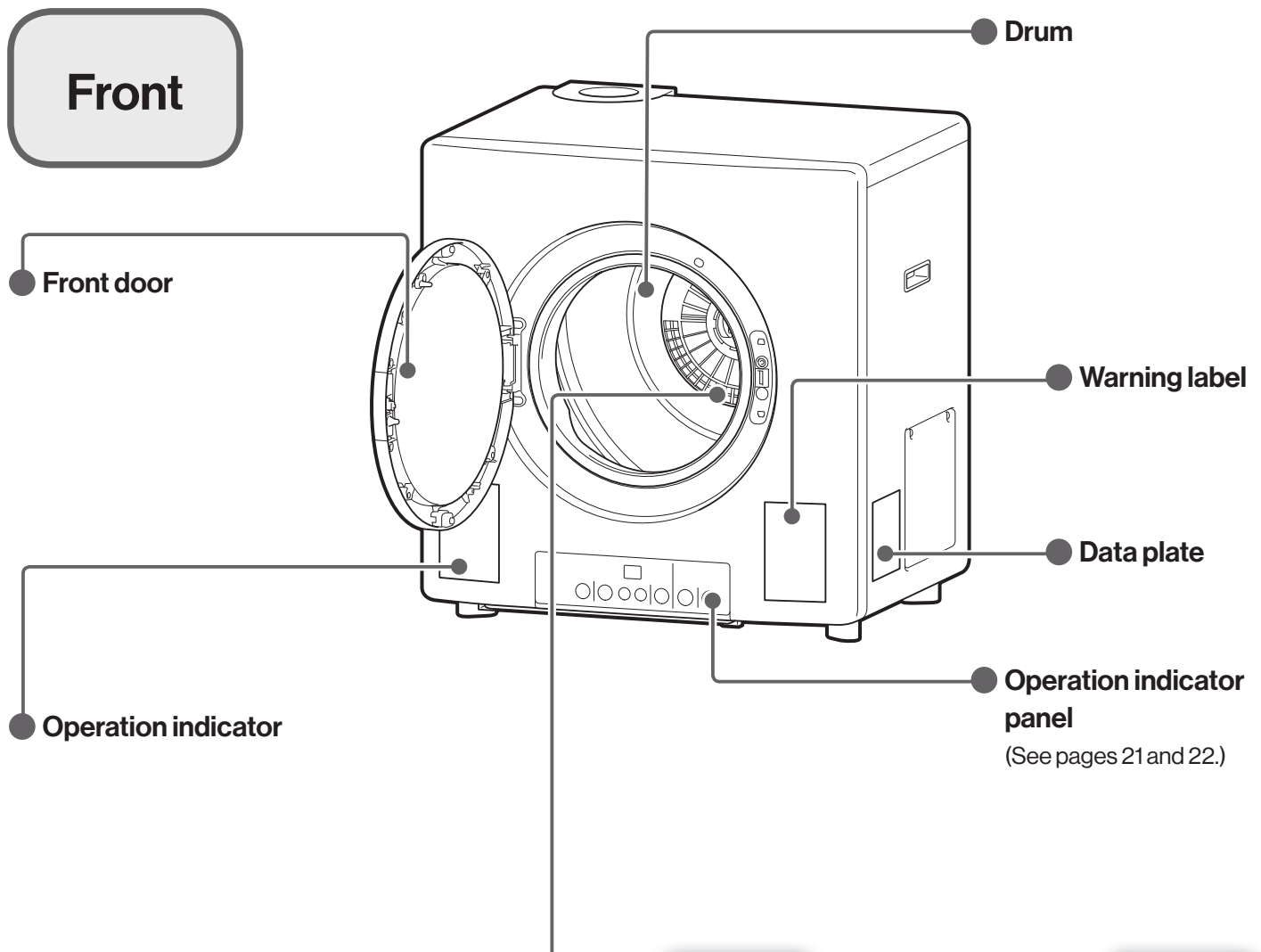
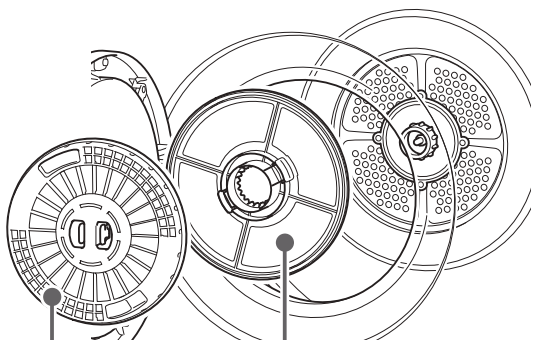

Figure shows a left-opening door.



Lint filter

This prevents fabric lint from being discharged from the equipment. (See pages 41 and 42.)



- Lint pocket (light blue)
- Filter (black)

Accessories



- Operating Instructions



- Exhaust Humidity Top Assy

- Drying rack for small items

The rack is already located inside the drum at purchase. Be sure to take the rack out before using the equipment.

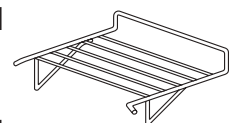

Names & Functions of Parts

Operation indicator panel

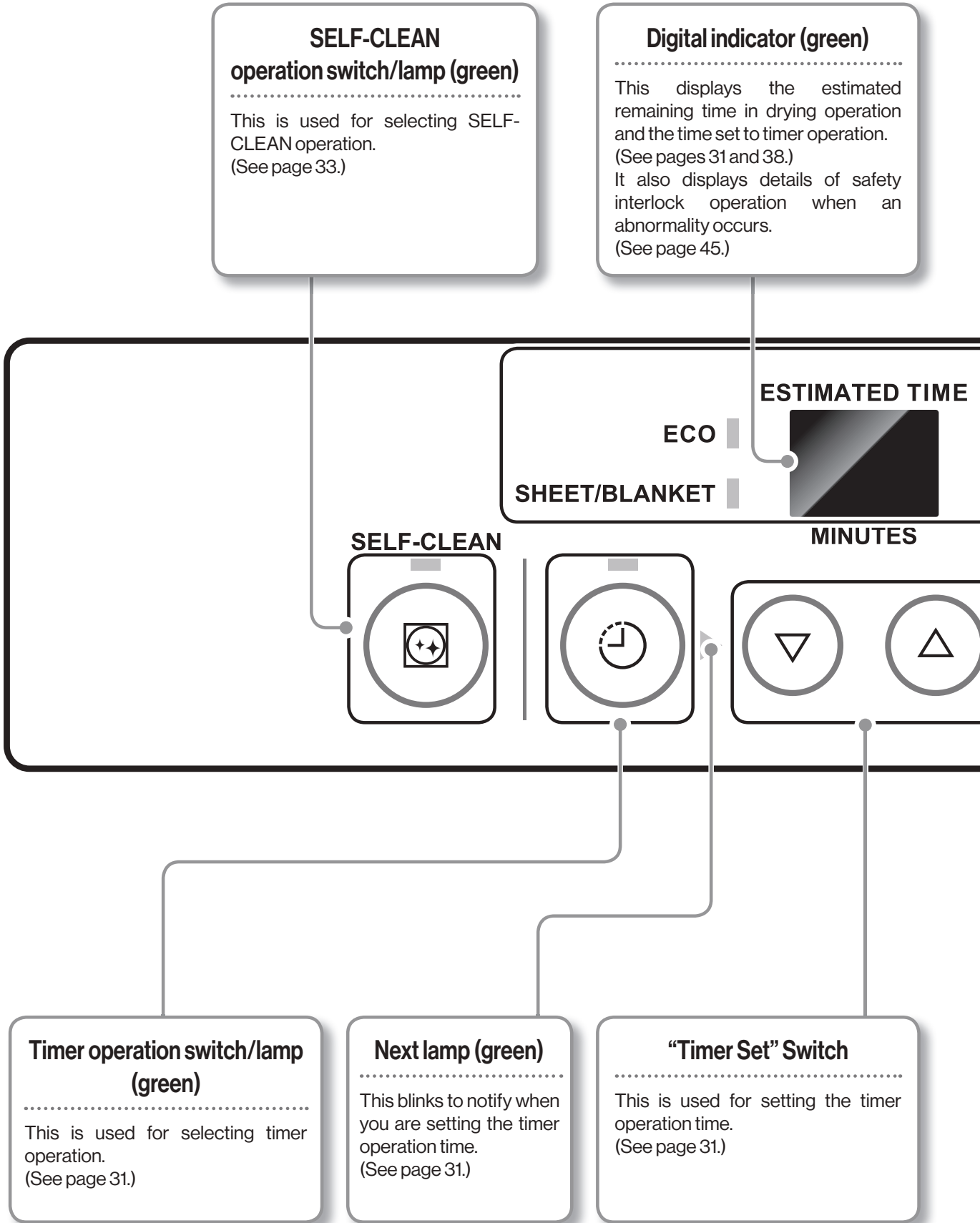

Operation/combustion lamp (green/red)

Lamp indications
 (lit green) In operation
 (lit red) Gas burning in progress
 (blinking green) Paused
 (See pages 28, 32 and 34.)

Filter cleaning lamp (red)

This lights to notify you when too much lint has accumulated on the lint filter inside the equipment. When this lamp is lit (red) or is blinking, perform maintenance on the lint filter. (See page 41.)

SOFTEN&COOL lamp (green)

Air is blown into the drum while it is operated intermittently (drum is rotated for one minute approximately every four minutes) together with cool operation after drying ends. This makes it less likely for wrinkles to occur, and keeps clothes fluffy during drying. During cool operation, this lamp lights (green).

- * To immediately stop cool operation, perform the following:
1. Press the "Start / Pause" switch to stop operation.
 2. Open the front door, and be sure to remove the clothes.
 3. With the front door open, hold down the "Power" switch until you hear a beep. (See pages 29.)

GENERAL

THICK

PROGRAM

CLEAN FILTER

SOFTEN & COOL

Course selection switch/lamp (green)

This is used to switch the operation course.

- Each press switches the course.



(See page 28.)

"Start / Pause" switch

Start/pause operation.



"Power" Switch

This turns the power ON and OFF.

If the power is left ON, it is automatically turned OFF after approximately ten minutes. (auto off)

Before Using the Equipment

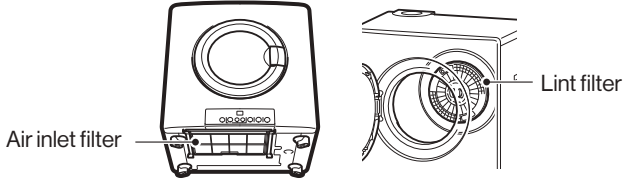
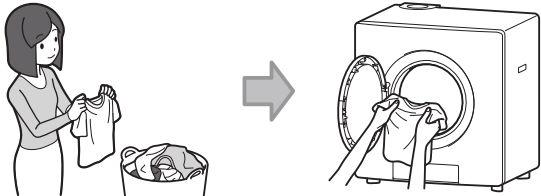
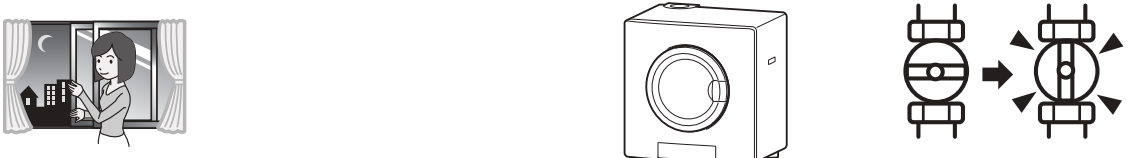
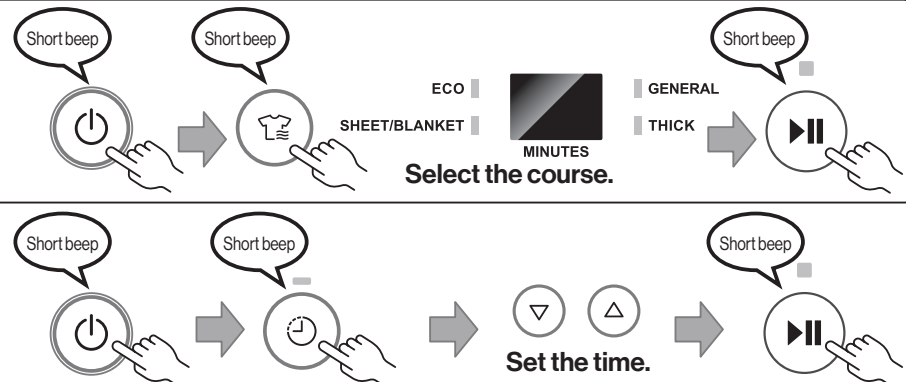
Flow of Operations

<p>1</p> <p>Check the filter</p>	<ul style="list-style-type: none"> • Check attachment of the air inlet filter and lint filter.  <p>Air inlet filter</p> <p>Lint filter</p>
<p>2</p> <p>Sort clothes</p>	<ul style="list-style-type: none"> • Course operation To select drying course, see page 25. • Timer operation • Sort the clothes to match operation or drying course.  <p>Note: Check for any clothes that cannot be dried. See page 24. Note: Check the amount of clothes that can be dried in a single operation. See page 26. Note: Some types of clothes are subject to precautions such as how they should be folded. See page 26.</p>
<p>3</p> <p>Prepare for operation</p>	<p>1. Course operation 2. Insert the power plug. 3. Close the front door. 4. Open the gas valve.</p> 
<p>4</p> <p>Start operation</p>	<ul style="list-style-type: none"> • Course operation For details, see page 27. • Timer operation For details, see page 31.  <p>Short beep</p> <p>ECO GENERAL</p> <p>SHEET/BLANKET THICK</p> <p>MINUTES</p> <p>Select the course.</p> <p>Short beep</p> <p>Short beep</p> <p>Set the time.</p> <p>Short beep</p>
<p>5</p> <p>Remove the clothes</p>	<p>1. End operation</p> <p>2. Remove the clothes</p> <p>3. Turn the power off</p>  <p>(3 beeps)</p> <p>With front door open</p> <p>Beep</p>

Items You Must Not Dry

Items that cause fire

- Clothes with oil, chemicals, etc. on them (including floor cloths and towels)
- Clothes with resin (cellulose type) on them
- Clothes containing polypropylene fiber (See page 9.)

Items that damage clothes themselves

Silk products

These sometimes lose their shape or their colors run.



Wool products / wool fabric

These sometimes shrink or their colors run.

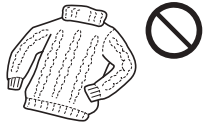

Leather products

These sometimes lose their shape.



Items with a “do not tumble dry” symbol

* “Tumbler drying” refers to drying clothes in a rotating drum type dryer.

Items that are easily affected by heat

- Items that use polyurethane
- Lacework products (curtains, tablecloths, etc.)
- Duvet covers with lace on them
- Cushions, soft toys, etc.

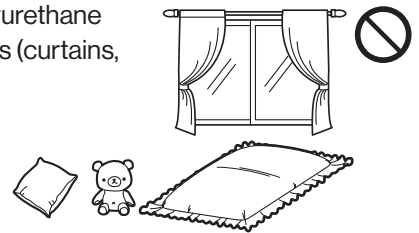

Items with dry cleaning pictograms

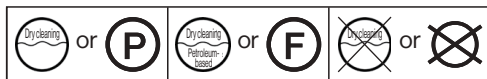

Clothes that might shrink

- Clothes that use linen, regenerated fiber (rayon), etc.
- Knit-woven clothes

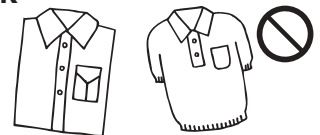

Items with a “dry flat” or “hang dry” symbol

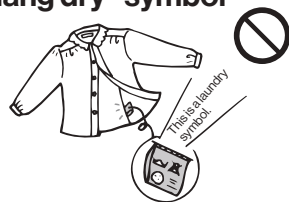
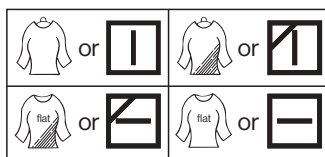

Clothes with emblems or stickers that are attached by a hot iron, etc.

Heat might cause emblems or stickers to peel off or adhesive to melt.



Items that may damage the equipment

Duvets or starched clothes

This may block the filter or cause a similar malfunction.

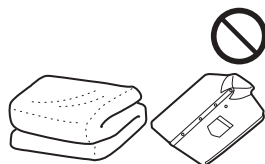

Daily necessities other than clothes

Mats, carpets, umbrella, wigs, breakables, etc.

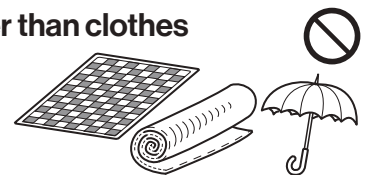

Items such as cushions, etc. that contain cotton padding or urethane (sponge)

This may block the filter or cause a similar malfunction.



Clothes, etc. with poor permeability

(place mats, rain coats, anoraks, waterproof sheet <picnic ground sheets, mats, etc.>, vinyl products, nursing aprons, etc.)
These may block the filter or cause a similar malfunction.



How to Select Courses

Microcomputer control performs automatic operation based on the detected amount of clothes and how dry they are (excluding timer operation). Moreover, the ideal course can be select to suit the type of clothes.

GENERAL

- **Regular clothes that are washed daily (9 kg)**
- **Towels (5 kg)**

Note: When these cannot be dried by the GENERAL course, try the THICK course.

Underwear



Towels



Long-sleeved shirts



THICK

- **Thick, difficult-to-dry clothes (9 kg)**

Jeans



Sweat shirts

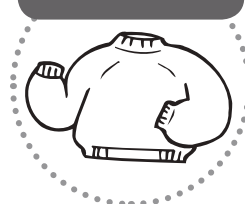

Winter clothing

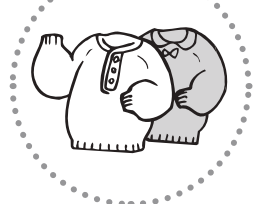

SHEET/BLANKET

- **Items that are hard to dry, such as sheets and duvet covers**
- **Items that are difficult to dry, such as blankets (Meyer blankets)**

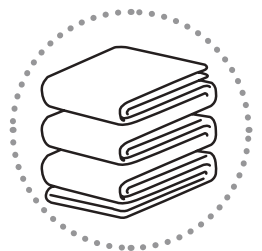
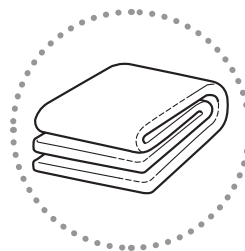

ECO

Reduce gas consumption and dry slowly

- **Dry to some extent by blowing air, and then finish by warm air operation.**
- **It takes about 1.5 times longer than GENERAL course.**

Operating time and gas consumption vary depending on the usage environment conditions.

(On days when clothes are difficult to dry, such as cold days and rainy days, the ventilation operation is stopped and immediately switched to warm air operation.)

Underwear



Long-sleeved shirts



Approximate Drying Weights and Drying Times

Type of Clothes	Weight of 1 Item (size)	Amount of Clothes That Can Be Dried in a Single Operation.	Drying Time
Long-sleeved shirts (mixed spun fiber)	Approx. 200 g	Approx. 45	Approx. 90 minutes
Work clothes tops and bottoms (mixed spun fiber)	Approx. 800 g	Approx. 11 sets	Approx. 85 minutes
Pajama tops and bottoms (mixed spun fiber)	Approx. 500 g	Approx. 18 sets	Approx. 90 minutes
Towel (cotton)	Approx. 80 g	Approx. 62	Approx. 80 minutes
Meyer blankets (acrylic)	Single size	2	Approx. 80 minutes
Sheets (100% cotton)	Single-size duvets 150 x 210 cm	6	Approx. 95 minutes

Note: The table above shows reference drying times when drying clothes that have been spun-dried 5 minutes in a fully automatic washing machine at a room temperature of 20°C.

Note: Set the volume of towels that can be dried in a single operation slightly lower than other clothes since their volume during drying swells to approximately 1.5 times other clothes. Drying times also become longer or uneven drying occurs with regular clothes when too many clothes are forced into the dryer.

Note: The drying time sometimes is longer than the times in the table above depending on the type, thickness, etc. of the fabric.

Note: Drying weight is the weight when clothes are dry.

Information

- **In the following instances, the drying time increases.**
 - When clothes have not been sufficiently spun-dried
 - When the surrounding temperature is low
 - When the lint filter is blocked with lint
 - When the room is insufficiently ventilated

How to fold sheets/blankets

• Items such as sheets and duvet covers that are difficult to dry when rolled up

Put sheets and duvet covers folded individually into the dryer.

If they do not dry when rolled up, repeat the same operation.

Up to 6 single-size items can be dried at a time, or up to 3 double-size items.

• Blankets (Meyer blankets) and other hard-to-dry items





Fold the blanket in two lengthwise and then fold it into a zigzag.

You can only dry two blankets at a time.

* When drying new blankets, a little fabric may fall out and accumulate in the lint filter, but this is just waste fabric from the blanket.

* If the blanket is not dry enough due to insufficient spin-drying, etc., turn it over and dry it again.

■ Blankets that can be dried

Single-size products weighing 3.0 kg or less, made of 100% synthetic fiber with  or ,  or  pictograms.

- Acrylic blankets
- Tufted blankets
- Woven blankets

The blanket will be damaged if it is dried using a course other than the SHEET/BLANKET course.

■ Do not dry:

- Long-piled blankets with piles of 10 mm or more (Blankets will be no longer fluffy)
- Electric blankets
- Blankets made of 100% wool
- Items marked with "Do not tumble dry"

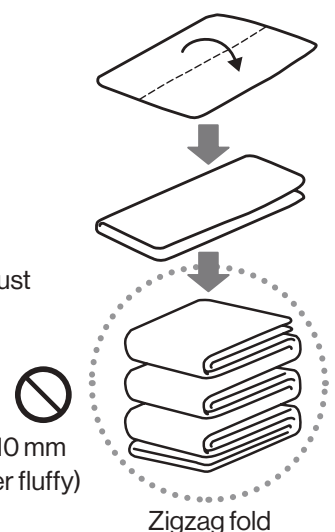

How to Use Drying Course Operation

- Select the drying course to match the type of clothes.

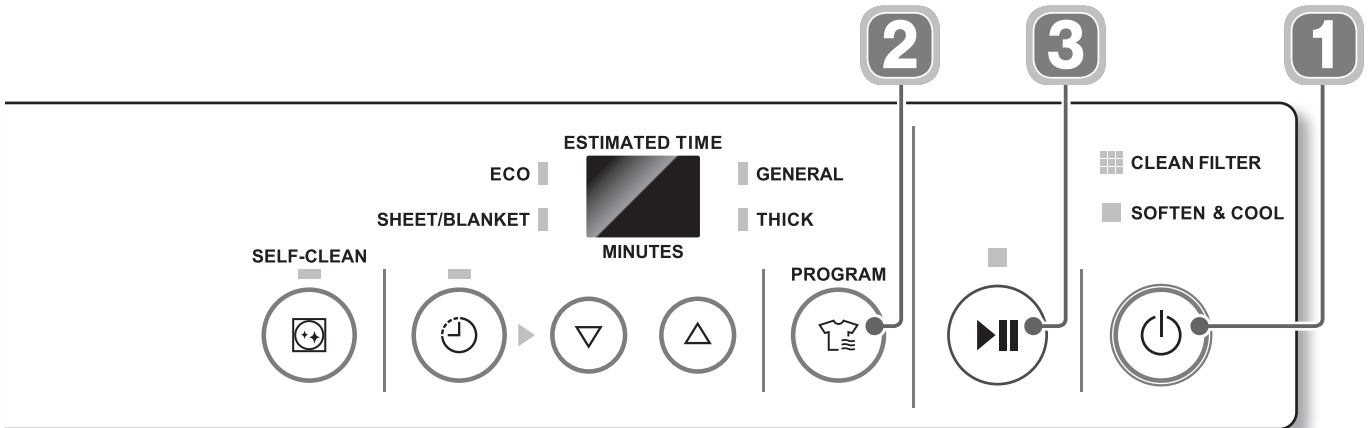

Caution

- Before opening or closing the front door, make sure that there are no people or obstacles in the immediate surrounding area, and gently open or close with your hand on the door. Opening or closing the door with excessive force may cause an injury or damage the equipment.

Information

- When the front door is opened during operation, the operation/combustion lamp lights (green) and operation stops. Drying operation is resumed when the front door is closed. (If the front door is left open for five minutes or more, the buzzer sounds "2 short continuous beeps repeated non-stop". Close the front door. The buzzer stops sounding, and the dryer automatically stops after cool operation.)

Note

- If clothes are dried while they are still spun-dried, the clothes might become entangled or wrinkled. Be sure to smooth out wrinkles before putting clothes in the dryer.

1

Put clothes inside, close the front door, and press .

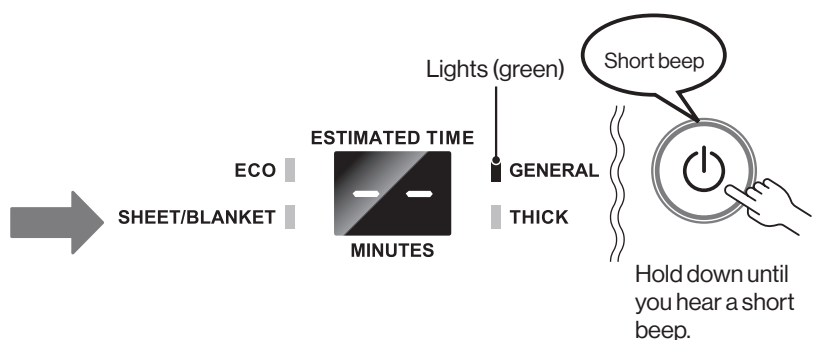
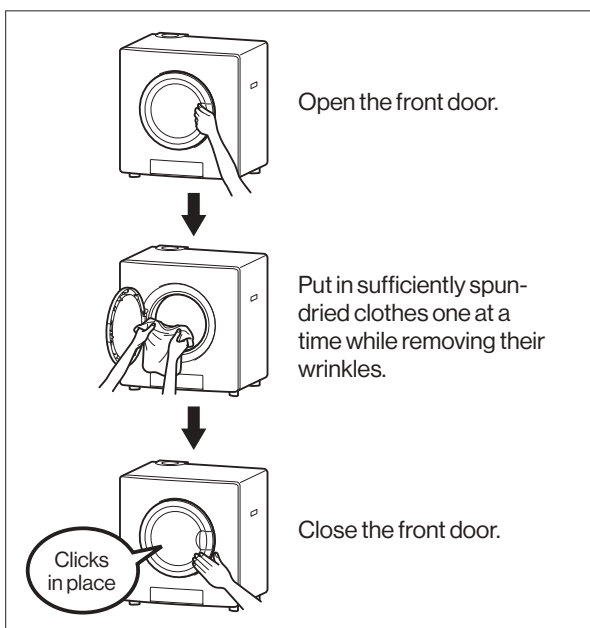

Information

- After the first use, the previously selected drying course is displayed.

2 Press and select the course.

Select the operation course to match the type of clothes. (See page 25.)

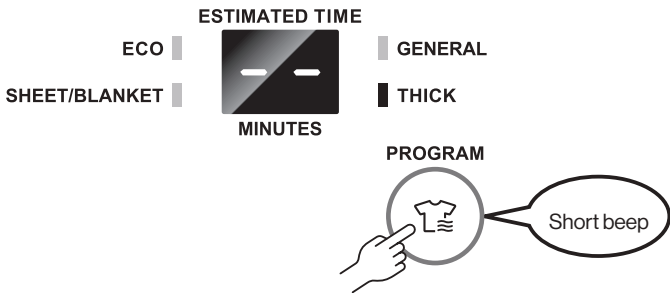

Information

- Each press switches the course as follows.



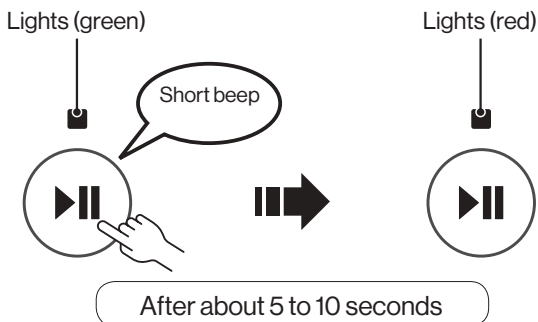

- The course can be switched even during operation. When the course is switched during operation, drying operation starts with the new course that you switched to after cooling operation of two minutes maximum.

3 Press .



Information

-  blinks for approximately two minutes until the estimated remaining time is displayed.
- If the  or  switch is pressed during operation, the drum stops. If the equipment is left in this state for approximately two minutes, drying operation is stopped, and cool operation is started.

4 When the buzzer sounds, remove the clothes.

When drying operation ends, the buzzer sounds (three continuous beeps). Before opening the front door, make sure that the operation/combustion lamp is off and the SOFTEN&COOL lamp is blinking or on (green).

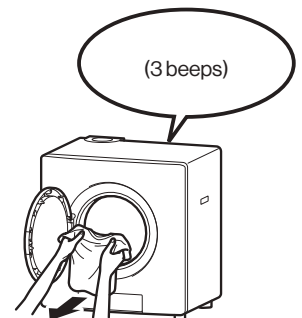

Caution

- Wait for the drum to come to a complete stop before removing clothes.
- Note that the lint filter and the area around the clothes removal port is hot immediately after operation ends.

Information

- Cool operation begins after one minute if clothes are not taken out. Also, to lower the temperature inside the drum after removing clothes, close the front door and resume cool operation after approximately two minutes. Operation automatically stops when cool operation ends.
- If drying operation is continued immediately after cooling operation, drying operation begins immediately after cooling operation of two minutes maximum.
- For details on how to stop cool operation, see pages 29.

How to Use Drying Course Operation

The temperature inside the drum is automatically lowered after drying ends. (cool operation)

Cool operation

The inside of the drum is hot after drying ends. Since oil remaining on clothes may cause spontaneous combustion, cool operation is automatically started one minute after drying ends. Cool operation involves three minutes of continuous operation followed by intermittent operation of the drum (drum is rotated for one minute approximately every four minutes) for a maximum of 76 minutes.

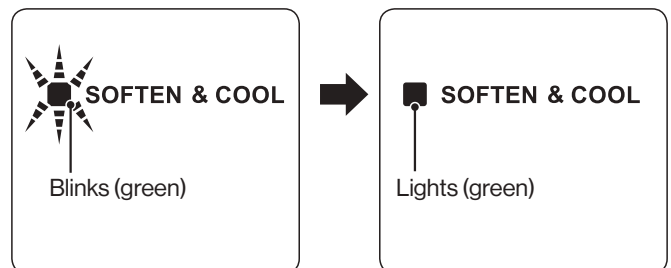

1 minute after drying operation ends

During cool operation



Note: Drying ends quickly when the temperature inside the drum is low.

How to stop cool operation

Press , and when the drum has come to a complete stop, press  with the front door open.



With front door open

Warning

- When stopping cooling operation, be sure to remove clothes. Oil remaining on clothes also may cause spontaneous combustion.



How to Use Timer Operation

- Decide on the drying operation time and perform drying. (Operation automatically stops after a fixed amount of time regardless of how dry the clothes are.)

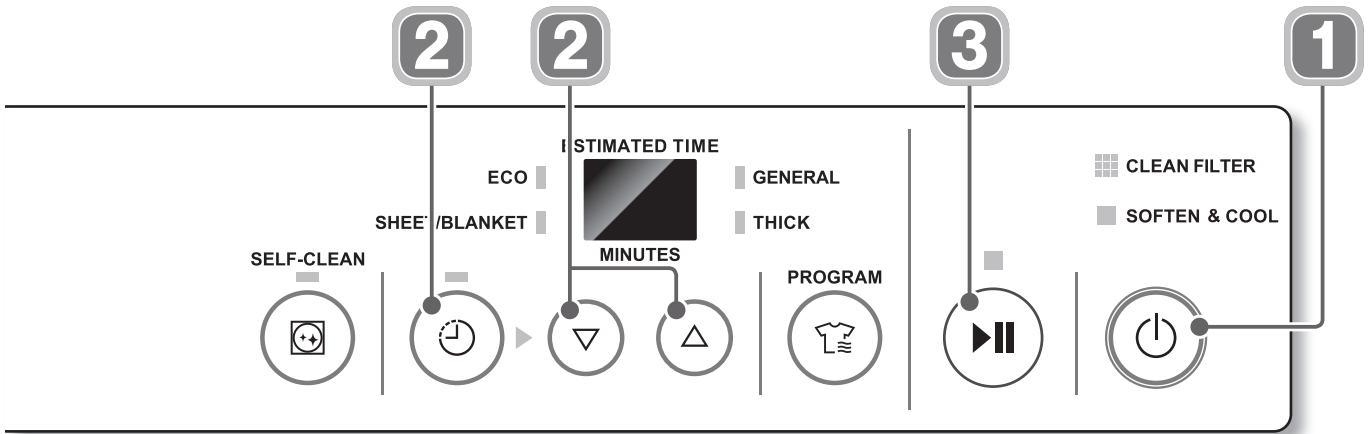

Caution

- Before opening or closing the front door, make sure that there are no people or obstacles in the immediate surrounding area, and gently open or close with your hand on the door. Opening or closing the door with excessive force may cause an injury or damage the equipment.

Information

- When the front door is opened during operation, the operation/combustion lamp lights (green) and operation stops. Drying operation is resumed when the front door is closed. (If the front door is left open for five minutes or more, the buzzer sounds "2 short continuous beeps repeated non-stop". Close the front door. The buzzer stops sounding, and the dryer automatically stops after cool operation.)

Note

- If clothes are dried while they are still spun-dried, the clothes might become entangled or wrinkled. Be sure to smooth out wrinkles before putting clothes in the dryer.
- Automatic operation is not matched to how dry the clothes are. If the clothes are insufficiently dry, perform operation again.

1

Put clothes inside, close the front door, and press .

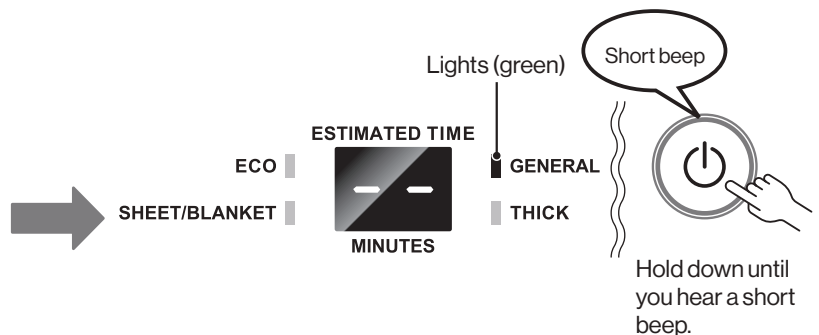
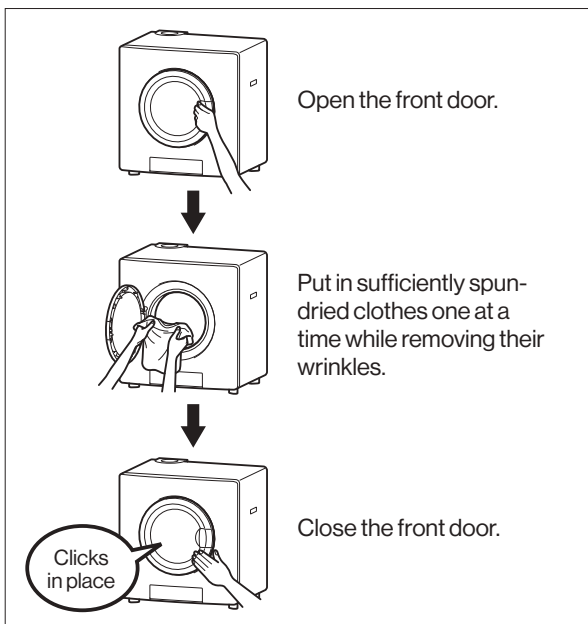



Information

- After the first use, the previously selected drying course is displayed.

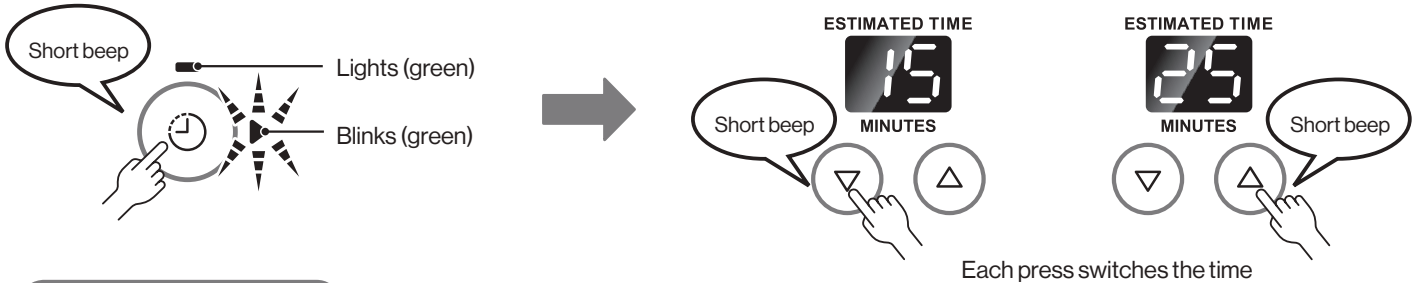
2 Press and , and set the timer time.





Information

- The timer operation time can be set within the range 5 to 90 minutes. (5 to 30 minutes can be set in 5-minute increments, and 30 to 90 minutes can be set in 10-minute increments.)
- To cancel timer operation, press . Timer operation cannot be stopped even by pressing .

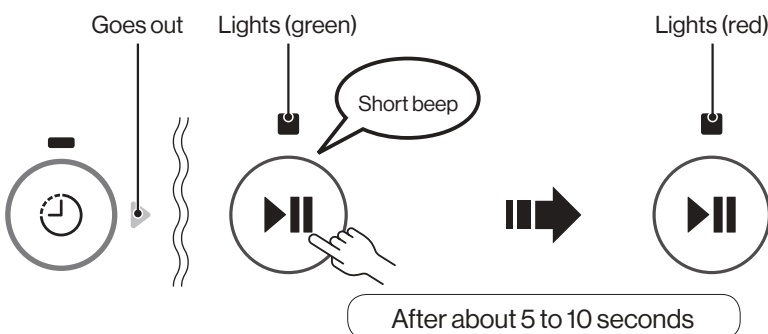
3 Press .



Information

- If the  or  switch is pressed during operation, the drum stops. If the equipment is left in this state for approximately two minutes, drying operation is stopped, and cool operation is started.

4 When the buzzer sounds, remove the clothes.

When drying operation ends, the buzzer sounds (three continuous beeps). Before opening the front door, make sure that the operation/combustion lamp is off and the SOFTEN&COOL lamp is blinking or on (green).

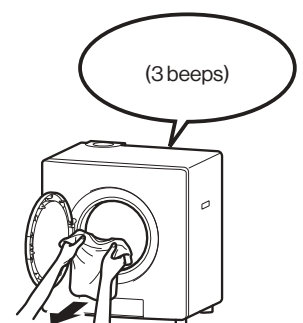

Caution

- Wait for the drum to come to a complete stop before removing clothes.
- Note that the lint filter and the area around the clothes removal port is hot immediately after operation ends.

Information

- Cool operation begins after one minute if clothes are not taken out. Also, to lower the temperature inside the drum after removing clothes, close the front door and resume cool operation after approximately two minutes. Operation automatically stops when cool operation ends.
- If drying operation is continued immediately after cooling operation, drying operation begins immediately after cooling operation of two minutes maximum.
- For details on how to stop cool operation, see pages 29.

How to Use SELF-CLEAN Operation

- This mode operates with the drum empty and cleans the inside of the drum (about three minutes). It sterilizes the inside of the drum with warm air of 80°C or higher.

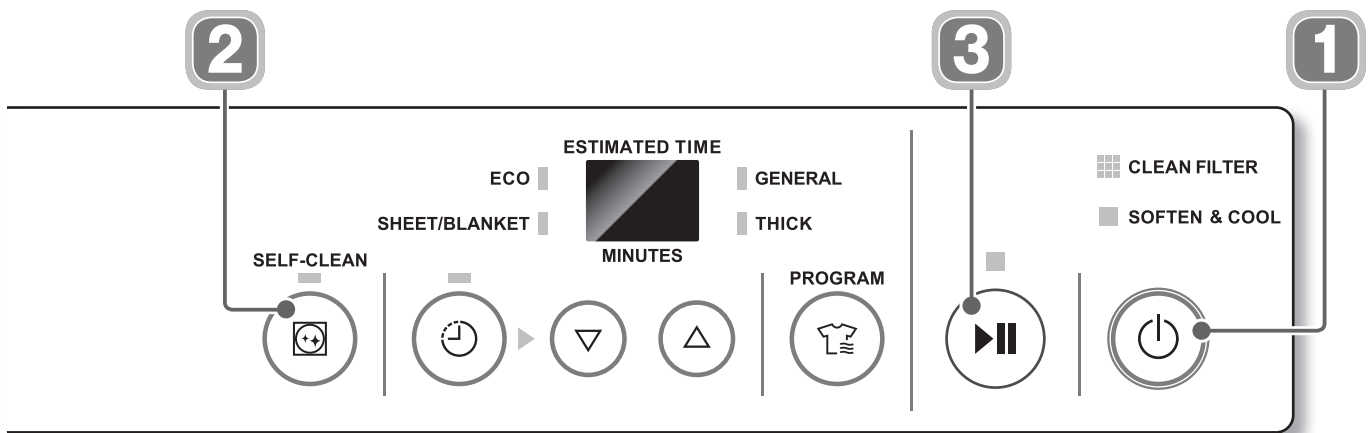

Caution

- Do not put clothes in.
- This is not a drying course.
- Before opening or closing the front door, make sure that there are no people or obstacles in the immediate surrounding area, and gently open or close with your hand on the door. Opening or closing the door with excessive force may cause an injury or damage the equipment.

Information

- When the front door is opened during operation, the operation/combustion lamp lights (green) and operation stops. SELF-CLEAN course will resume when the front door is closed. (If the front door is left open for five minutes or more, the buzzer sounds "2 short continuous beeps repeated non-stop". Close the front door. The buzzer stops sounding, and the dryer automatically stops after cool operation.)

1

Make sure there are no clothes in the drum, and then press .

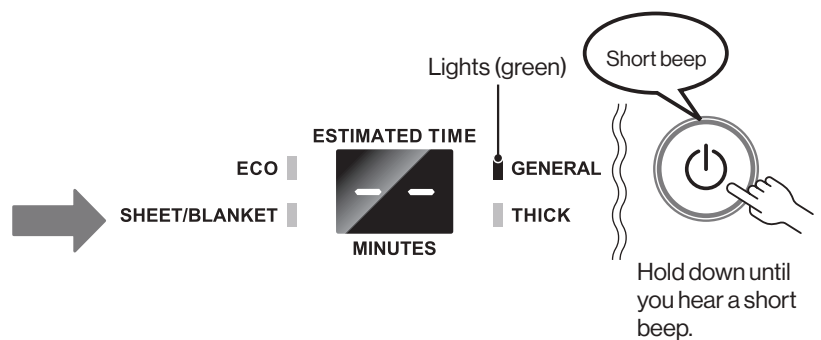
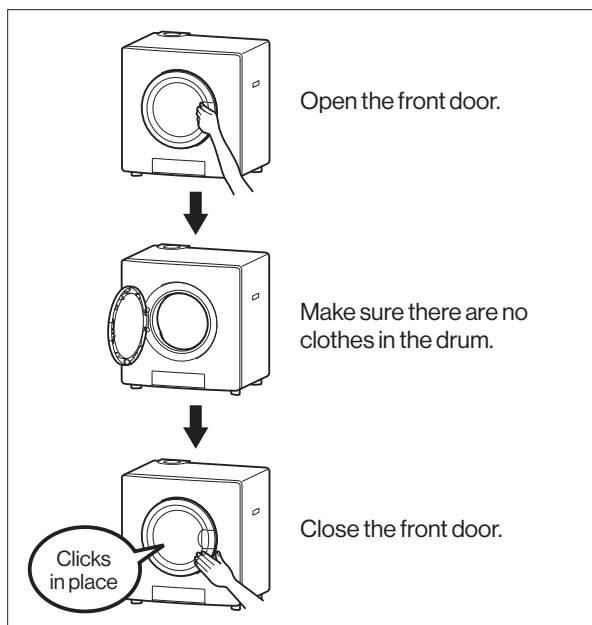



Information

- After the first use, the previously selected drying course is displayed.

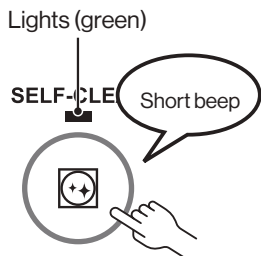
2 Press and select the SELF-CLEAN course.





Information

- To cancel SELF-CLEAN operation, press  or .
- SELF-CLEAN cannot be stopped even by pressing .

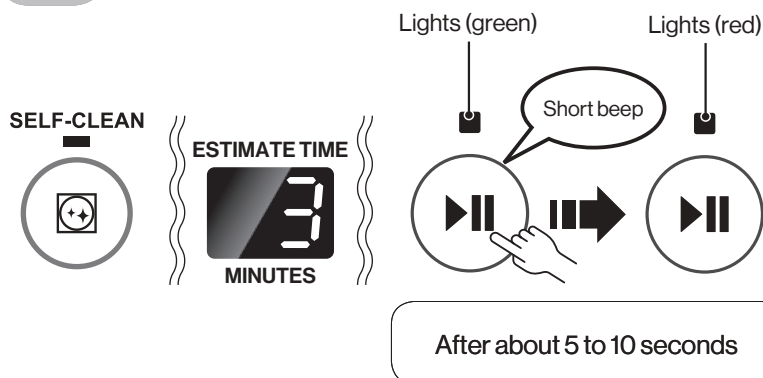
3 Press .



Information

- If the  or  switch is pressed during operation, the drum stops. If the equipment is left in this state for approximately two minutes, drying operation is stopped, and cool operation is started.
- When  is pressed while the drum is stopped, after a cooling operation of two minutes maximum, the operation/combustion lamp will light up red and SELF-CLEAN operation will resume.

4 When the buzzer sounds, the drum will stop.

When SELF-CLEAN course ends, the buzzer sounds (three continuous beeps). Before opening the front door, make sure that the operation/combustion lamp is off and the SOFTEN&COOL lamp is blinking or on (green).

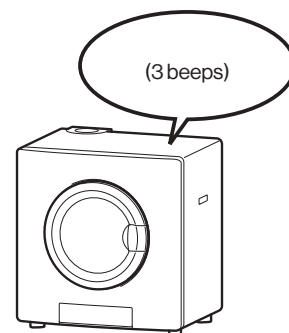

Caution

- Note that the lint filter and the area around the clothes removal port is hot immediately after operation ends.

Information

- Cool operation begins after one minute if clothes are not taken out. Also, to lower the temperature inside the drum after removing clothes, close the front door and resume cool operation after approximately two minutes. Operation automatically stops when cool operation ends.
- If SELF-CLEAN course is continued immediately after cooling operation, SELF-CLEAN begins immediately after cooling operation of two minutes maximum.
- For details on how to stop cool operation, see pages 29.

Buzzer Functions

- Buzzer functions notify you by sounding a buzzer when a switch is operated or when a safety interlock has operated. At purchase, the buzzer is set to sound to notify you. However, you can turn the buzzer sound off, if necessary.

Switch Operation and Equipment Operating State	Buzzer sound
At switch "ON/acceptance"	Short beep
At switch "OFF/cancel"	Beep
At end of drying	3 beeps
* Filter cleaning lamp blinks (at end of operation)	10 short continuous beeps
* Forgot to close front door	Short continuous beeps repeated non-stop
* At operation of safety interlock	20 beeps
When acceptance of switch operation is prohibited	2 short continuous beeps

Information

- Items marked with a * are notified by a buzzer even when the buzzer sound is canceled.

To cancel the buzzer sound

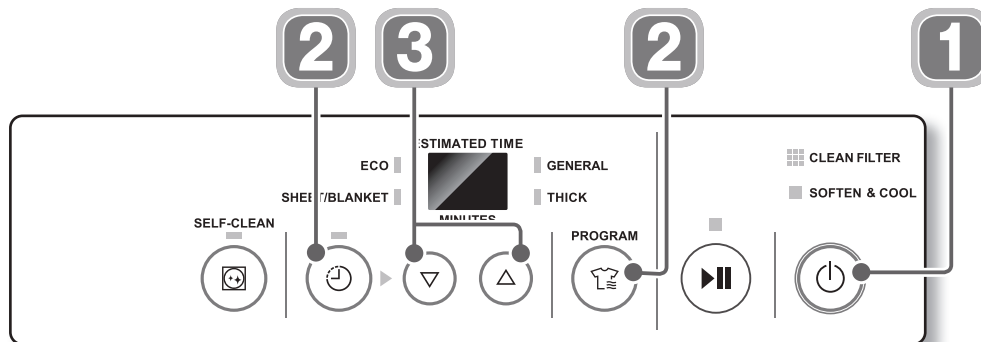

- 1** Close the front door, press and turn the power ON.

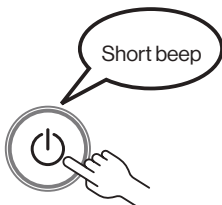

- 2** Hold and simultaneously for at least two seconds.

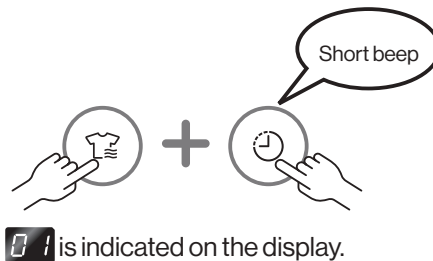

- 3** Press the "Timer Set" switch .

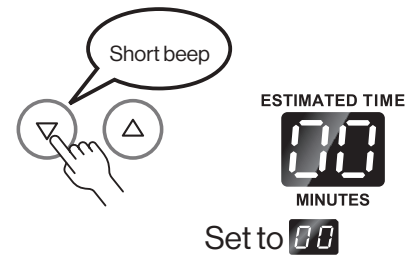

The buzzer sound is turned "OFF". This completes the setting. Turn the power OFF.

Information

- To return the buzzer sound to the "ON" settings, perform **1** **2** again, and press the "Timer Set" switch .



The buzzer sound set to is turned "ON".

Advanced Operation

Take care not to put too many clothes into the equipment.

- Too many clothes in the dryer might result in the drum stopping at start of operation or during operation.
 - Maximum loading point when spun-dried clothes are put in the drum

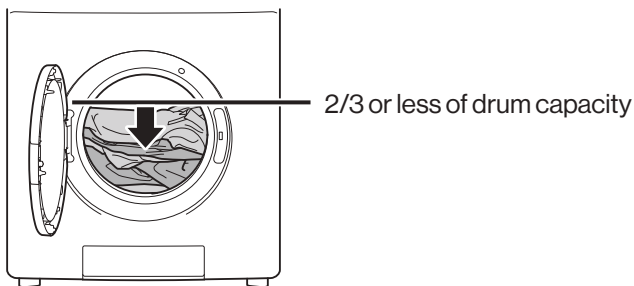

Reducing uneven drying and wrinkles

- Put in the clothes one at a time while removing their wrinkles.
- Reduce the amount of clothes slightly to 70 to 80% of the standard drying capacity.
- When there are very few clothes to dry, put in dried bath towels, etc. to eliminate uneven drying.
- When drying a mixture of thick and thin clothes, select the THICK course.

Clothes with fasteners and hooks

- Close fasteners and hooks and turn clothes inside out before drying them. This reduces cloth damage. It also makes it less likely for damage inside the drum to occur.



Clothing that easily produces lint

- Sort clothes such as new towels that easily produce lint and dry them separately. Lint sticks to clothes that contain man-made fibers.



Reducing the amount of static electricity

- Use softener during washing.

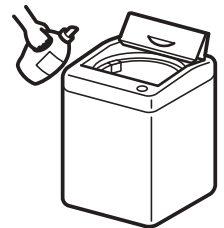

Remaining time display (course operation)



- The estimated remaining time is displayed matched to the amount of clothes and their dampness.

<Example>

ESTIMATED TIME



MINUTES

- * With course operation,  is displayed blinking for approximately two minutes after operation is started.
- * In the case of ECO course operation,  will blink for about six minutes after the start of operation.

- The estimated time is an approximate time for reference only. It may differ from the actual end time. Also, while the filter cleaning lamp is lit, the estimated remaining time is sometimes not displayed correctly.
- The remaining time is displayed in 5-minute increments. When only one minute is left,  is displayed.
- To adjust the estimated time until end of operation and the actual end time, the same time is sometimes displayed for five minutes or more, or the remaining time is sometimes lengthened or shortened.

Daily Inspection and Maintenance

Performing Daily Maintenance

- **Is the power cord damaged?**

- Inspect the power cord for damage and the power plug for accumulation of dust.
(See pages 6 and 11.)

- **Is the lint filter or air inlet filter blocked with dust? Are the filters set correctly in place?**

- Check the filter cleaning lamp to see if it is lit or blinking. (See pages 22 and 41.)
- Check the air inlet filter to see if dust is building up. (See pages 19 and 40.)
- Check the lint filter and air inlet filter to see if they are set correctly in place. (See pages 40 to 42.)

Preparing for maintenance

1. Stop operation, and make sure that the equipment has sufficiently cooled down.
2. Close the gas cock.
3. Remove the power plug from the power outlet.
4. Put on gloves before starting daily maintenance.

Note

- If the operation indicators or warning labels attached to the equipment become dirty or are no longer legible, wipe off dirt with a soft, dry cloth.

Maintenance Methods

Tools and Detergents Used for Daily Maintenance

Tools/detergents that may be used



Soft cloth

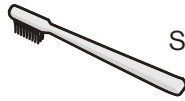

Soft toothbrush



Neutral detergents for kitchens
(for washing vegetables and dishes)



Tools/detergents that must not be used

Items that may cause painted surfaces to degenerate, peel or become discolored, and resin parts to become discolored or crack



Chemical
wipes



Acid/alkaline
detergents
bleaching agents



Spray type
detergents

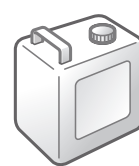

Thinner
Benzene
Alcohol

Maintenance of main unit (about once per month)

- Clean dirty locations as required about once per month.
- Wipe with a soft cloth moistened with hot water and then wrung well. In the case of particularly stubborn dirt, wipe with a soft cloth moistened with neutral detergent for kitchen use.
- Make sure that the equipment body is not wet with water. If it is wet, completely wipe it dry.
- Perform daily maintenance particularly carefully when the equipment is not to be used for a long time.

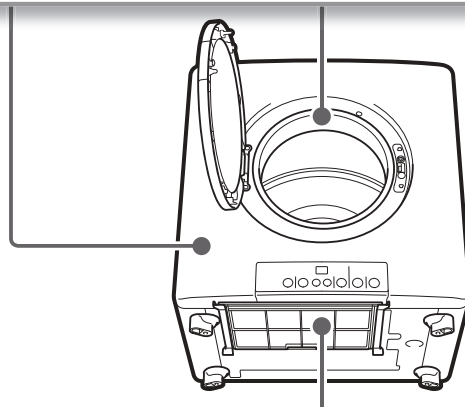

Maintenance of air inlet filter (about once per month)

1

Draw out the air inlet filter located at the bottom of the equipment body towards you to remove.

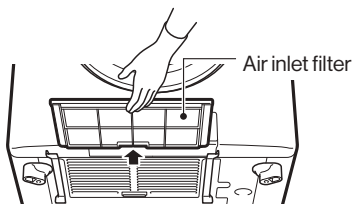

2

Remove any dust with a soft toothbrush or similar item.

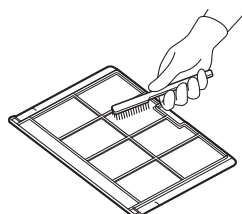

3

Insert the air inlet filter along the rails on the base of the main unit and push in as far as possible.



Make sure to insert the front and back of the filter in correctly.

Maintenance Methods

Before performing daily maintenance, allow the equipment to cool down, close the gas cock, remove the power plug, and put on gloves.

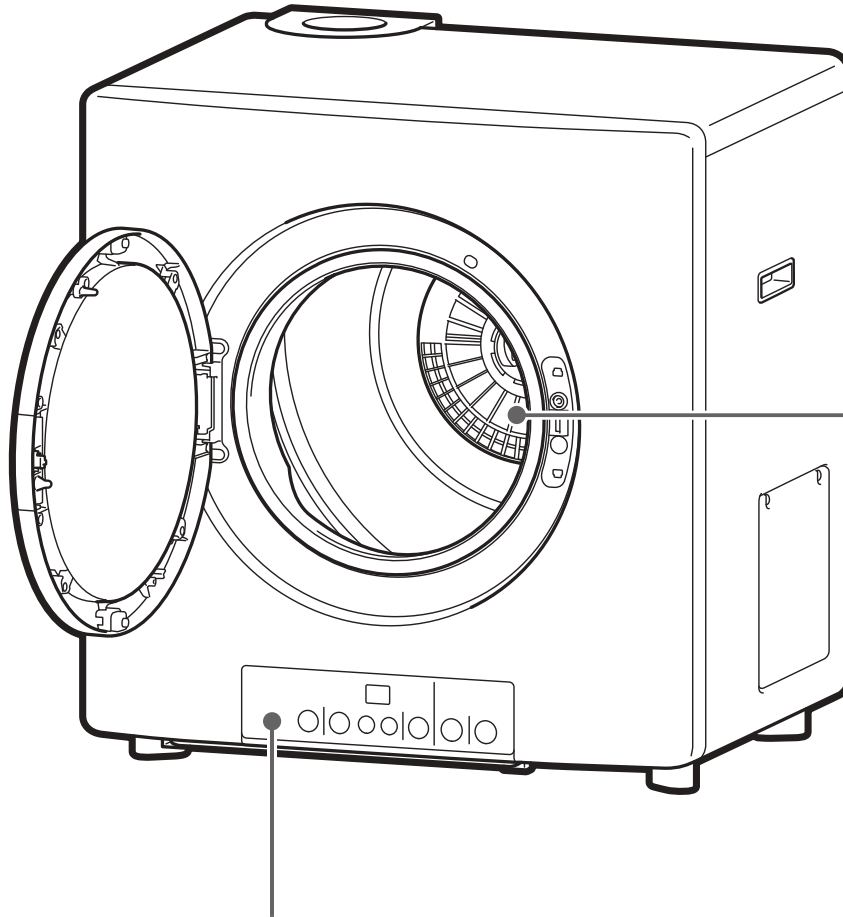

Filter cleaning lamp

The filter cleaning lamp lights or blinks when too much lint has accumulated on the lint filter. This increases the drying time or may cause the inside of the equipment to overheat. So, be sure to clean the lint filter after drying ends.

When the filter cleaning lamp lights during drying operation, the buzzer sounds after operation ends. (When the front door is opened, the buzzer stops, and the lamp goes out.)

During operation

Lights (red)



CLEAN FILTER

After end of operation

Blinking (red)



CLEAN FILTER

10 short continuous beeps

⚠ Caution

• Note that the lint filter is hot immediately after operation ends.

• Be sure to set the lint filter in place after cleaning.

Cleaning the Lint Filter (every time after use)

The filter cleaning lamp lights or blinks when too much lint has accumulated on the lint filter. This increase the drying time or may cause the inside of the equipment to overheat. So, be sure to clean the lint filter after drying ends.

1 Press the lint pocket knob and draw out the lint filter (set) towards you.

The lint filter set comprises two parts, a lint pocket and a filter. (See page 20.)

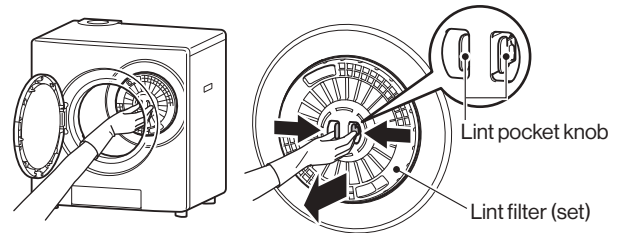

2 Remove the filter by holding the filter knob between your fingers.

Press the filter knob between your fingers and remove the lint pocket.

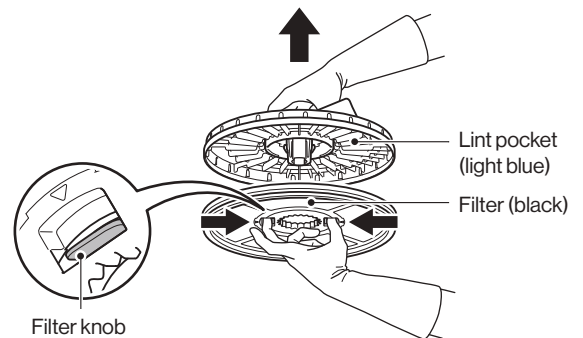

3 Remove lint from the filter lint pocket.

In the case of stubborn dirt

• Wash in water with neutral detergent for kitchen use. Thoroughly remove any water and allow the lint filter to dry sufficiently before setting it in place.

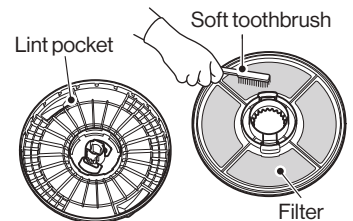

4 Set the filter and lint pocket in place.

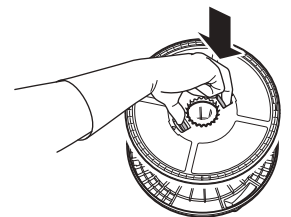

5 Set the lint filter (set) in place.

Press the lint pocket knob between your fingers.

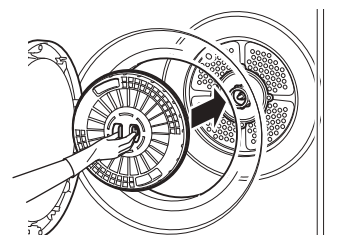

Push in the lint filter until you hear it click into place.

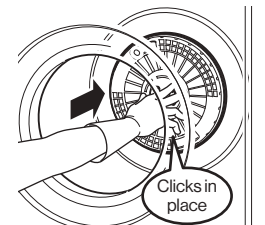

Troubleshooting

If you think that a problem has occurred, after careful checking you might find that the problem is not an equipment malfunction. Before asking for repair, check the following points again. If this does not remedy the problem or you do not know the cause, contact the store of purchase or call Customer Services Hotline.

In Cases Such As This	Check These Items	Reference Page
No operation	Has a power outage occurred?	—
	Has the fuse in your home blown or has the circuit breaker been actuated?	—
	Is the power plug inserted into the power outlet?	23
	Has the “Power” or “Start / Pause” switch been pressed?	23, 27 to 35
	Is the front door completely closed?	13, 23, 27, 31, 33
No ignition • The operation/combustion lamp does not light (red)	Is the gas cock fully open?	23
	Is there air remaining in the gas pipe?	44
	Is the gas meter operating?	—*1
Drying time is long Drying is unsatisfactory	Is filter cleaning lamp lit or blinking? Clean the lint filter after end of operation.	41, 42
	Are there too many clothes in the equipment?	26
	Are clothes sufficiently spun-dried?	17
	Was the front door open during operation?	17
	Did you add clothes during operation?	17
	Did you switch the course during operation?	28
	Is the discharge duct blocked?	17
	Are you drying thick clothes by a course other than THICK?	25
You can smell gas	Is the gas pipe damaged?	4

*1 Contact your nearest gas utility company (gas supplier).

The Following Symptoms Are Not Equipment Malfunctions

Symptom	Cause and Remedy	Reference Page
Equipment also operates after clothes are removed. Equipment also operates after the drying end buzzer sounds	Cool operation is being performed to lower the temperature inside the drum. (three minutes of continuous operation followed by intermittent operation of the drum for a maximum of 76 minutes) Wait for the equipment to automatically stop. To stop operation midway, press the "Start / Pause" switch, and when the drum has come to a complete stop, press the "Power" switch with the front door open. The SOFTEN&COOL lamp goes out and operation stops.	29
The combustion lamp (red) does not light at all	Air sometimes enter the gas hose when the equipment is used for the first time or the equipment has not been used for a while. The re-ignition function automatically operates just once.	—
	Cool operation is being performed to lower the temperature inside the drum. Wait for the operation/combustion lamp to light (red). (approx. 2 minutes at most)	32, 34
	When the ignition/light out safety interlock operates, "E2" is displayed, and cool operation stops midway, operation proceeds to ignition after the equipment is cooled for two minutes (replacement with fresh air) before start of the next operation. (Excluding ECO course) Wait for the operation/combustion lamp to light (red).	—
White smoke comes out of the discharge duct	White smoke sometimes appears to come out of the discharge port on cold days. This is not a malfunction.	—
A short popping sound is heard when gas is lit	This is the gas ignition sound. This is not an abnormality.	—
You can hear the sound of metal objects rubbing against each other or objects bumping against something.	This sound occurs when buttons, fasteners, etc. attached to clothes rub against or bump against the drum. This is not an abnormality. (Turn clothes inside out before drying them.)	37
You can hear a clicking sound after operation is stopped.	This sound occurs when the burner is shrinking after it has expanded due to heat. This is not an abnormality.	—
The spark sound of ignition is slower than start of fan rotation	A delay of approximately 5 seconds is provided to prevent explosive ignition. This is not an abnormality.	—
The displayed remaining time does not change for a while or increases	To adjust the estimated time until end of operation and the actual end time, the same time is sometimes displayed for five minutes or more, or the remaining time is sometimes lengthened or shortened.	38

Displayed Messages

- When the safety interlock operates, you will be notified on the display and by a buzzer, and cool operation will automatically be performed.





 CLEAN FILTER

Lit  SOFTEN & COOL

During cool operation, the SOFTEN&COOL lamp lights.

Wait for this lamp to automatically go out.

The blinking display goes out by pressing the “Power” switch after cool operation ends.

Display <small>For displays marked by *, the buzzer does not sound.</small>		Safety Interlock	Function
	At power outage <out>*	Safety interlock at power outage	Gas supply and operation is stopped when a power outage occurs. Also, the equipment cannot be used during a power outage.
	At power ON again <blinks>		
	<blinks>	Temperature detection thermistor (blocked filter error)	Gas supply is stopped and cool operation is automatically started when lint blocks the lint filter or when the inside of the equipment overheats abnormally.
	<blinks>	Ignition/light out safety Interlock	Gas supply is stopped and cool operation is automatically started when lighting of the pilot light fails during ignition.
	<blinks>		Gas supply is stopped and cool operation is automatically started when flames go out during use.
	<blinks>	Temperature detection thermistor (discharge temperature thermistor)	Gas supply is stopped and cool operation is automatically started when the inside of the equipment overheats abnormally.
	<blinks>	Temperature detection thermistor (clothes temperature thermistor)	Gas supply is stopped and cool operation is automatically started when the inside of the equipment overheats abnormally.
	<blinks>	Switch circuit safety interlock	Gas supply is stopped and cool operation is automatically started when an abnormality occurs on the start/pause switch circuit.
	<blinks>	Temperature detection thermistor (blow temperature thermistor)	Gas supply is stopped and cool operation is automatically started when the inside of the equipment overheats abnormally.

Note







- Even if inspection is performed according to the descriptions in the table below, repair is necessary when the safety interlocks frequently operate in the same way or other messages are displayed. Contact the store of purchase or call Customer Services Hotline.

Information

- Cooling operation stops temporarily when the front door is opened during cool operation or when the "Start / Pause" switch is pressed. Cool operation is resumed by closing the front door or by pressing the "Start / Pause" switch again. Wait for cool operation to stop.
- For details on how to stop cool operation midway (turn the blinking display OFF), see pages 29.

Cause	Remedy	Reference Page
<p>This is not an equipment malfunction. This occurs because of a power outage or the power plug was removed during operation.</p>	<p>When power is turned ON again, press , then display is 00. And cool operation operates for approximately 80 minutes. In this case, wait for cool operation to end before performing operation again.</p>	—
<p>This occurs when there is insufficient air for combustion.</p> <p>Lint has accumulated on the lint filter or the lint filter is blocked with lint.</p> <p>Thin clothing with poor permeability is covering the lint filter.</p> <p>There is too much washing loaded in the equipment.</p>	<p>Wait approximately 80 minutes for cool operation to end before inspecting and performing operation again. (When there is too much washing loaded in the equipment, remove the clothing or remove clothing with poor permeability, then perform operation again.)</p>	24, 26, 40 to 42
<p>This occurs when dust has built up inside of the equipment.</p> <p>The discharge tube is blocked.</p>	<p>Repair is necessary. Contact the store of purchase or call Customer Services Hotline.</p>	—
<p>This occurs, for example, when the gas cock is closed or was not completely open.</p>	<p>Wait approximately 2 minutes for cool operation (replacement with fresh air) to end before inspecting and performing operation again.</p>	23
<p>This occurs, for example, when the gas cock is closed or was not completely open.</p>	<p>Wait approximately 80 minutes for cool operation to end before inspecting and performing operation again.</p>	
<p>This occurs when oxygen in the room has dropped to a very low level.</p>	<p>Perform operation again after sufficiently ventilating the room.</p>	13
<p>The discharge tube is blocked.</p>	<p>Repair is necessary. Contact the store of purchase or call Customer Services Hotline.</p>	—
<p>Lint has accumulated on the lint filter or the lint filter is blocked with lint.</p> <p>There is too much washing loaded in the equipment.</p>	<p>Wait approximately 80 minutes for cool operation to end before cleaning the lint filter for use. (When there is too much washing loaded in the equipment, remove the clothing or remove clothing with poor permeability, then perform operation again.)</p>	26, 41, 42
<p>This occurs when the start/pause switch circuit short-circuits or the switch is held down for 10 seconds or more.</p>	<p>Wait approximately 80 minutes for cool operation to end before inspecting and performing operation again. Repair is necessary when operation cannot be performed again. Contact the store of purchase or call Customer Services Hotline.</p>	—
<p>Lint has accumulated on the lint filter or the lint filter is blocked with lint.</p> <p>Thin clothing with poor permeability is covering the lint filter.</p> <p>There is too much washing loaded in the equipment.</p>	<p>Wait approximately 80 minutes for cool operation to end before cleaning the lint filter for use. (When there is too much washing loaded in the equipment, remove the clothing or remove clothing with poor permeability, then perform operation again.)</p>	24, 26, 41, 42
<p>The discharge tube is blocked.</p>	<p>Repair is necessary. Contact the store of purchase or call Customer Services Hotline.</p>	—

Displayed Messages

Display		Safety Interlock	Function
	<blinks>	Drum rotation sensor (drum rotation abnormality)	Gas supply is stopped and cool operation is automatically started when the drum does not rotate or drum rotation is insufficient.
	<blinks>	Fan rotation sensor (discharge fan rotation abnormality)	Gas supply is stopped and cool operation is automatically started when the discharge fan does not rotate, drum rotation is insufficient or the drum rotates abnormally.
	<blinks>	Ignition/light out safety interlock (ignition failure for 5 times continuous)	Gas supply is stopped and cool operation is automatically started when lighting of the pilot light fails (continuously for 5 times) during ignition.
	<blinks>	Error can be canceled	Gas supply and operation are stopped when the drum does not rotate or drum rotation is insufficient.
		Error cannot be canceled	
	<blinks>	Overheat prevention device (thermocouple)	Gas supply is stopped and cool operation is automatically started when lint blocks the lint filter or when the inside of the equipment overheats abnormally.
	<out>*	Overheat prevention device (temperature fuse)	Gas supply, operation are stopped when the inside of the equipment overheats abnormally.
		Overcurrent prevention device (current fuse)	The current fuse and gas supply and operation are stopped when an overcurrent flows.
Display other than the above		Safety interlocks other than the above	A safe shutdown occurs when an abnormality other than the above occurs.

Cause	Remedy	Reference Page
There is too much washing loaded in the equipment.	Reduce the amount of washing, and perform operation again. (as a guideline after spin drying, within 13 kg)	26, 37
The electrical circuit of a motor, etc. is malfunctioning.	Repair is necessary. Contact the store of purchase or call Customer Services Hotline.	—
Thin clothes with poor permeability or a mat is covering the lint filter.	Remove the clothes with poor permeability or the mat, then perform operation again.	24
The discharge tube is blocked.	Repair is necessary. Contact the store of purchase or call Customer Services Hotline.	
The electrical circuit of a motor, etc. is malfunctioning.		
This occurs, for example, when the gas cock is closed or was not completely open.	Wait approximately 2 minutes for cool operation (replacement with fresh air) to end before inspecting and performing operation again.	23
There is too much washing loaded in the equipment.	Reduce the amount of washing, and perform operation again. (as a guideline after spin drying, within 13 kg)	26, 37
The electrical circuit of a motor, etc. is malfunctioning.	Repair is necessary. Contact the store of purchase or call Customer Services Hotline.	—
This occurs when there is insufficient air for combustion.	Wait approximately 80 minutes for cool operation to end before inspecting and performing operation again. (When there is too much washing loaded in the equipment, remove the clothing or remove clothing with poor permeability, then perform operation again.)	24, 26, 40 to 42
Lint has accumulated on the lint filter or the lint filter is blocked with lint.		
Thin clothing with poor permeability is covering the lint filter.		
There is too much washing loaded in the equipment.		
This occurs when dust has built up inside of the equipment.	Repair is necessary. Contact the store of purchase or call Customer Services Hotline.	—
The discharge tube is blocked.		
This occurs when there is insufficient air for combustion.	Repair is necessary. Contact the store of purchase or call Customer Services Hotline.	24, 26, 40 to 42
Lint has accumulated on the lint filter or the lint filter is blocked with lint.		
Thin clothing with poor permeability is covering the lint filter.		
There is too much washing loaded in the equipment.		
The discharge tube is blocked.	Repair is necessary. Contact the store of purchase or call Customer Services Hotline.	—
This occurs when an electrical circuit short-circuits.		
Wait for the equipment to stop automatically before performing operation again. Repair is required when the safety interlock operates again. Contact the store of purchase or call Customer Services Hotline.		—

Specifications and Dimensional Diagram

Specifications

Model	RDT-90-RM-S
Dimensional diagram (mm)	684 (Height) x 650 (Width) x 641 (Length)
Gas consumption	NG: 15,800 Btu/hr LPG: 15,200 Btu/hr
Weight (body)	33 kg
Standard drying capacity	9 kg
Standard drying time	90 minutes
Gas inlet connection	ø9.5 Hose end
Power	AC 240 V (50 Hz)
Power consumption	250 W (at standby, 0.2 W)
Length of power cord	1.5m
Safety interlocks	Ignition/light out safety interlock, temperature detection thermistor, automatic return motor protector (drum motor) overheat prevention device, drum rotation sensor, fan rotation sensor, switch circuit safety interlock, overcurrent prevention device (current fuse), door switch

* Standard drying time is based on the measurement method specified by JIS.
Clothes drying time is calculated based on the time taken to 70% dry clothes (50% cotton, 50% synthetic fiber).

Dimensional diagram

(Unit: mm)

Top

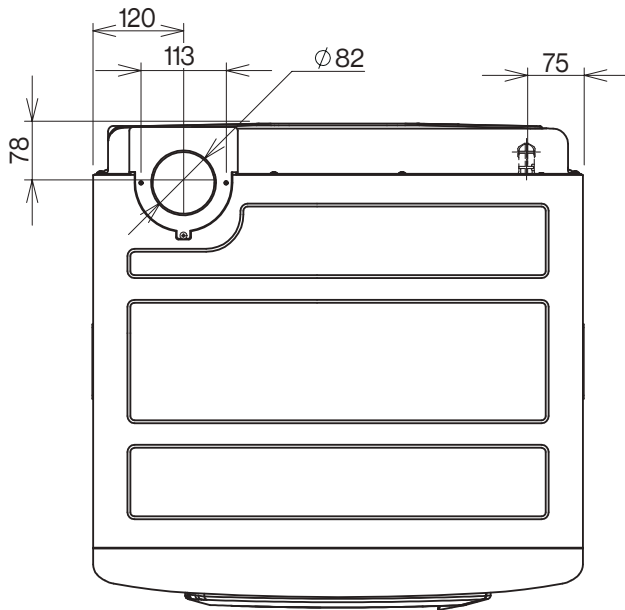

Front

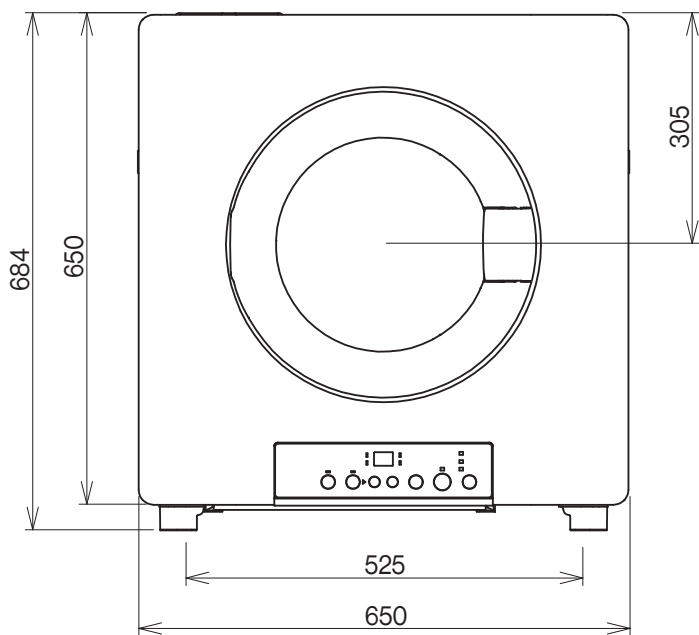

Side

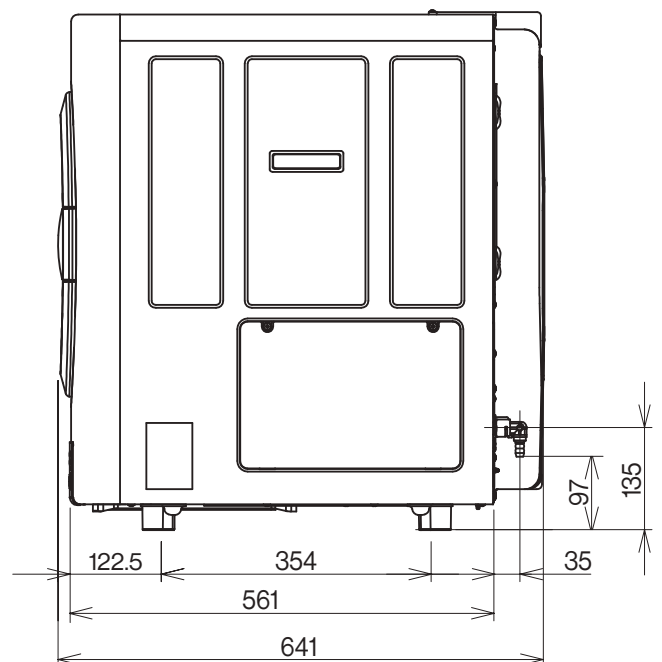



223694

RDT90-0274(00)
210600 ©