

# Rinnai

**Operation / Installation Manual**

**Chimney Hood**

**RH-C819-GB**

Rinnai Corporation

English

# TABLE OF CONTENTS

English

Page 1 - 7

# CONTENTS

Safety warnings	1
Specifications & components	3
Installation	4
Operation	5
Maintenance and care	6
Troubleshoot	7



## IMPORTANT

To register your product warranty, please paste the serial numbers stickers enclosed with the packaging on your warranty card. Please contact your local Rinnai Customer Care Centre should you require further assistance.

# SAFETY WARNINGS

Please read this user manual thoroughly before attempting to use this appliance for the first time. This manual contains important information on safe installation, use and care of the appliance. Keep these instructions for reference and pass them on to future user.

This appliance is not intended for use by persons (including children) with reduced physical, sensory or mental capabilities, or lack of experience and knowledge, unless they have been given supervision or instruction concerning use of the appliance by a person responsible for their safety.

Children should be supervised to ensure that they do not play with the appliance.

There is a fire risk if cleaning is not carried out in accordance with the instruction;

CAUTION: Accessible parts may become hot when used with cooking appliances.

### Unpacking

- Do not use the appliance if there are obvious signs of transportation damage.
- If the power supply cord is damaged, it must be replaced by the manufacturer, its service agent or qualified technician to avoid hazard.
- Please ensure that young children do not play with plastic bag packaging.

### For the installer

- The extractor hood can be installed over gas and electric cook top. The recommended minimum installation height from the bench top to the bottom of the hood is 700mm (gas range) and 550mm (electric range) (Fig. 1).
- If the instructions for the installation of the gas hob specify a greater distance, this has to be taken into account.

### For the user

- The extractor hood is designed for domestic use to eliminate unpleasant odors from the kitchen. Do not use the hood for uses other than its specific purpose.
- Do not allow young children to play with or operate the appliance. Supervise its use by the elderly or infirm.
- Installation and repair should be attempted by qualified technical personnel only.
- It is dangerous to modify any part of this appliance. Tampering with electrical connections or mechanical parts can cause operation faults and may put the user at risk.
- Never leave high naked flames under the extractor hood when it is in operation. Always cover lit burners with cookware.

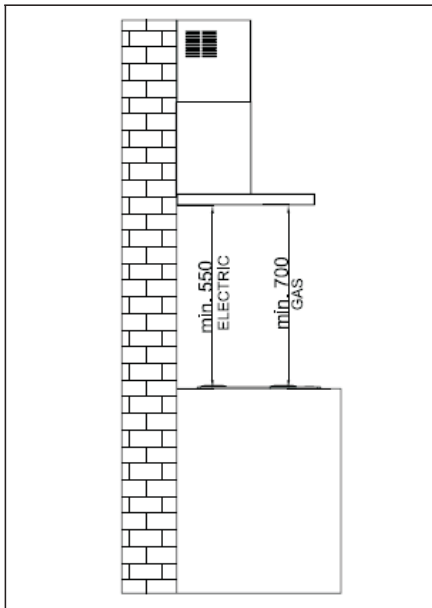

Fig. 1

- Always mount the extractor hood over the center of the hob.
- Ensure that the appliance is installed in a location with good and permanent ventilation.
- When making the electrical connections, check that
  - The mains voltage and frequency corresponds to the technical information shown on the rating plate.
  - Electrical connection must be made in accordance to local standards only. Check that the voltage in your area is correct before plugging in.
- Use an electrical connector with earth that is correct for your location. The electrical connection of this appliance must be connected to earth (*where applicable*):
  - Green & Yellow = EARTH; Blue = NEUTRAL; Brown=LIVE
- Ducted mode:
  - Connect the extractor hood to the exhaust duct through a pipe of minimum  $\varnothing 150\text{mm}$ . Use the shortest and straightest duct route possible.
  - Do not connect the extractor hood to exhaust ducts carrying combustion fumes.
  - Arrange proper ventilation if the extractor hood is used in conjunction with other appliances which are not supplied by electrical power e.g. gas burning appliances. The kitchen must have a direct opening to the outside in order to allow entry of fresh air.

*Note:* The manufacturer accepts no responsibility for complaints attributed to the design and layout of the pipe work.

- Do not flambé or grill with an open flame directly under the extractor hood. Flames could be drawn up into the hood by the suction and the grease filters may catch fire.
- Monitor cooking continuously as overheated oil increases the risk of self-ignition.
- Do not operate the extractor hood without a grease filter.
- It is important to clean and/or replace the filters at appropriate intervals.
- Grease deposits build-up increases the risk of fire.
- Always disconnect the unit from the power supply before carrying out any cleaning or maintenance work on the hood.
- Ensure that the power supply chord is free from any heat source or sharp objects.
- Multiple plugs and extension cables must not be used. Overloading is dangerous and may cause a fire hazard.

#### Disposal

- This appliance and its packaging are environmentally friendly and recyclable. Please help us to care for the environment by disposing the packaging in a proper manner and recycling any old appliances.
- Before disposing an old appliance, disconnect it from the power supply and cut the power supply cord to prevent hazards.

The manufacturer will not be held liable for any damages resulting from improper installation nor failure to adopt proper safety measures during installation and operational use of the appliance.

## SPECIFICATIONS

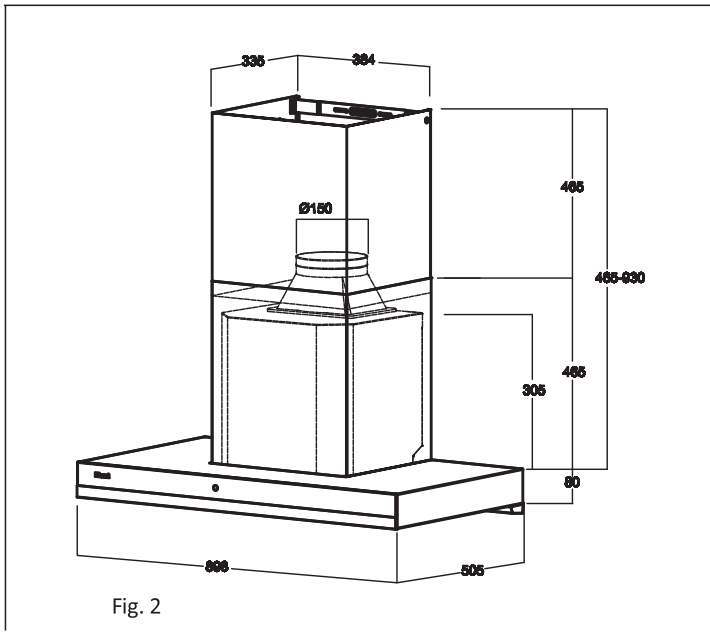

<b>Model</b>	<b>RH-C819-GB</b>
Voltage	220V - 240V / 50Hz
Power of	220W Motor
Power of	1 x 7W Lamp
Cable Length	1.5m
Appliance Dimension (W x D x H)	898 x 505 x 545~1010mm
<i>Note: The manufacturer reserves the right to change any technological improvement or modification without prior notice.</i>	

## COMPONENTS

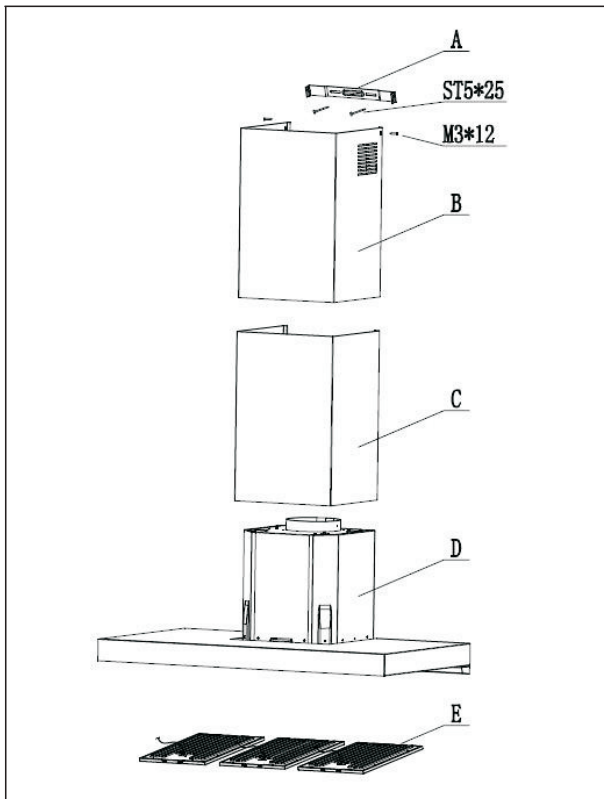

Re	Qt	Product components
A	1	Mounting bracket
B	1	Inner duct
C	1	Outer duct
D	1	Motor housing
E	3	Baffle filter
<b>Qty Installation components</b>		
	2	Screw M3 x 12
	2	Screw ST5 x 25
	2	Screw ST5 x 40
<b>Qty Documentation</b>		
	1	Operation / Installation Manual

Fig. 3

## INSTALLATION

This appliance can be installed in ducted or recirculation mode.

### Ducted mode (Fig. 4)

- In ducted mode, the extractor hood fan extracts the cooking vapours and passes them through the grease filter. The air then flows to the outside.
- The grease filter absorbs the solid particles in the cooking vapors.
- In this mode, **only aluminum filters are installed (charcoal filter is optional)**.

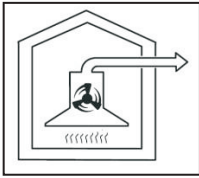

Fig. 4

### Connection to exhaust air pipe (Fig. 6)

- Attach  $\varnothing 150\text{mm}$  pipe directly to the air outlet and secure appropriately (Fig. 6).
- Connect pipe to the outdoor duct.

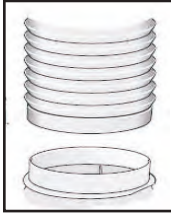

Fig. 6

### Wall mounting (Fig. 7 & 8)

Do ensure that the appliance is mounted on a solid surface which could withstand the appliance's weight.

- Draw a vertical line at the center of the wall.
- From bench top (see A), draw a horizontal line (see B) above minimum installation height level.
- Mark a reference point at C. Repeat this step on the other side.
- Drill  $\varnothing 8\text{mm}$  holes at center of marking points. Insert wall plugs in the wall.
- Fix the hood body to wall using 2(two) ST5 x 25 screws provided. Tighten screws firmly. Note: Adjust the hood body alignment if necessary (Fig. 9).
- Place mounting bracket on the wall at desired height level, aligning bracket center at vertical line (see D).
- Mark the center of the bracket holes and drill  $\varnothing 8\text{mm}$  holes. Insert wall plugs in the wall. Secure mounting bracket firmly using 2(two) ST5 x 25 screws provided.
- Fix the inner duct to both mounting bracket using 2(two) M3 x 12 screws provided (Fig. 8).
- Slide the outer duct downwards and ensure that it is well seated on the hood body.

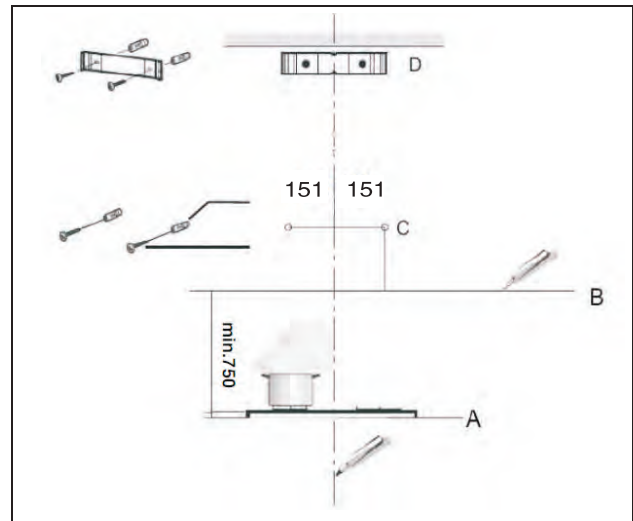

Fig. 7

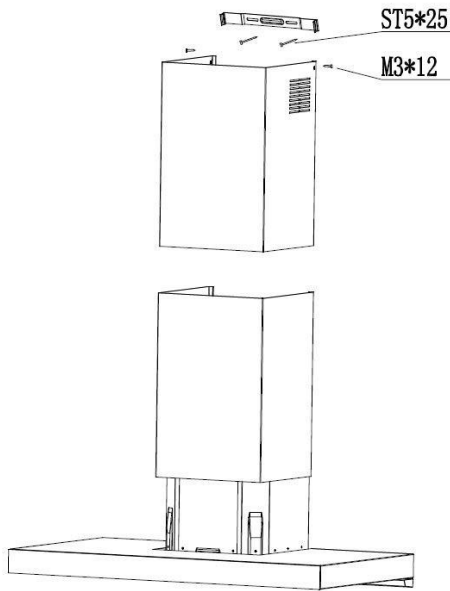

Fig. 8

### Aligning the hood body (if necessary) (Fig. 9)

- Before attaching hood body to wall, adjust the 2(two) screws located on the hood body mounting points.
- Hook the hood body onto the support screws and tighten the support screws fully.
- Adjust screws to level the hood body.



Fig. 9







Installation must be performed by qualified personnel only. The manufacturer declines all responsibility for improper installation and does not accept responsibility for appliance warranty in the event of damage caused by incorrect installation.

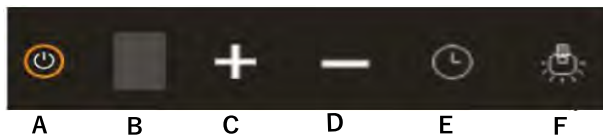



## OPERATION

To achieve better air extraction, we recommend you to switch on the blower a few minutes before starting to cook. Leave it on for approximately 15 minutes after cooking or till all cooking smell is completely removed.

**Switch control:** Touch the sensor buttons gently to operate this appliance.



- |   |   |  |
|---|---|--|
| A.  On/Off Switch        | B.  Display Window | C.  Fan Speed (increase) |
| D.  Fan Speed (decrease) | E.  Delay Timer    | F.  Light                |

1. When power up the hood,  the orange ring standby icon will light up.
2. Press once to select ON / OFF, the power on icon  and the rest of the operation icons will light up.
3.  Touch to increase the fan speed 1-2-3-P
4.  Touch to decrease the fan speed P-3-2-1
5.  Booster: Touch to increase the fan speed to P (high speed). After working for 10 minutes, P speed jump to Speed 3. When working in P, the delay function will not start.

6. Light : Touch to select on/off

7. Delay Stop Timer:

(i) Press Fan Speed 1, then press timer icon. Speed 1 will blink for 5 seconds and follow by timer icon blink.

(ii) Press the Delay stop Timer icon to select the require stop timing.

[Indication of "1" = 5 mins, "2" = 10 mins, "3" = 15 mins, "4" = 20 mins]

(iii) After the delay time reach, it will automatically jump to the motor speed display.

To exit the delay function, press the speed button to 0. The delay stop function will exit after 5 seconds.

8. **Clean and Fresh Function:** After power on, press and hold the delay stop timer icon for 3 seconds. You will hear a beep sound. The function will start after the beep sound. After 5 seconds, all lights will turn off. The timer will blink and the ON/OFF icon will indicate with an orange ring backlight. To disable, press the ON/OFF icons. All function icons will light up. Press the timer icon to disable.



9. When the cooker hood has been operated for 90 hours, an orange dot indicator will blink at the bottom right of the display square. This indicator is to remind you to clean grease filters. To cancel the reminder, press and hold the ON/OFF button for 5 seconds, and the operation hours will reset to zero.

When the cooker hood has been operated for 270 hours, an orange dot indicator will light up solidly at the bottom right of the display square. This indicator is to remind you to change to charcoal filters. To cancel the reminder, press and hold the ON/OFF button for 5 seconds, and the operation hours will reset to zero.



## MAINTENANCE AND CARE

Disconnect the power supply cord before carrying out any cleaning or maintenance activities. It is important to clean and/or replace the filters at appropriate intervals as grease deposits build-up increases the risk of fire. Do not operate the extractor hood without grease filter.

### S/S Baffle filter (Fig. 10)

- Filters are used to absorb the grease particles formed during cooking process. The filters must be removed and cleaned every week, depending on the frequency of usage. The filter can be removed by sliding out the 2 S/S panel (Fig10.1) Clean the filter either by hand or in the dishwasher.
- If cleaning manually by hand, soak the filters in warm detergent solution to ease the removal of grease. Brush the filters, rinse thoroughly and leave it to dry before refitting.
- If by dishwasher, select an appropriate wash program. Leave it to dry before refitting. Note: slight discoloration of the filter may occur.
- Removing and inserting the baffle filters:
  - To remove, always hold the baffle filter with one hand while depressing the handle and pull down the filter by the other hand. Remove the filter by unlocking the hook.(Fig.10.2)
  - To refit, slot the filter into position. Make sure that the handle is visible on the outside.

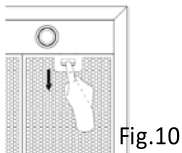

Fig.10

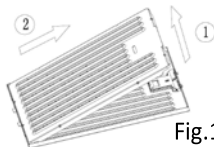

Fig.10.1

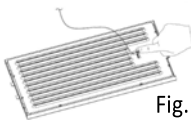

Fig.10.2

### Removing the grease filter

Kindly note that the grease filter may fall during removal from the unit and this will result in damages to both the filter and the hob below it. Please ensure that you hold the grease filter securely at all times when you are removing it from the unit. You are advised that the safety cable is not meant to support the grease filter after removal from the unit.

- Oil collector removing reference drawing steps (Fig.11)

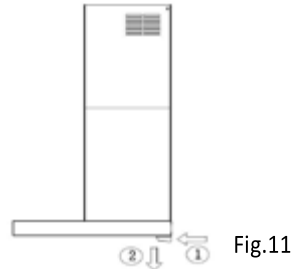

Fig.11

### Charcoal filter (where applicable) (Fig. 12)

- The charcoal filter should be replaced when it is dirty or discolored, or when the control panel shows time to replace.
- These charcoal filters are not washable and cannot be restored.

### Removing and inserting charcoal or aluminum charcoal filter. (Fig 12)

- Remove the saturated charcoal filter from the blower as shown.
- Fit in the new charcoal or aluminum filter.

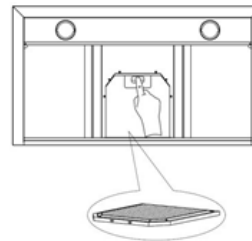

Fig.12

### Cleaning the appliance body

- Clean the extractor hood using warm detergent solution and a soft damp cloth. Wipe dry with a lint-free cloth.
- Avoid using corrosive or abrasive products that could damage the surface.

### Light replacement

- Kindly contact Rinnai customer care service for replacement of LED light bar.



You are strongly recommended to follow these safety instructions. The manufacturer will not be held liable for any damages to the appliance or any fire hazard due to failure to observe the above safety recommendations.

# TROUBLESHOOT

Problem	Possible Cause	Solution
Extractor hood does not function	No electrical supply	Check that plug is connected and main power switch is turned on
Poor airflow	Grease filters clogged with grease build-up	Clean the grease filters and refit when dry
	Charcoal filters clogged with grease build-up	Replace charcoal filters with new sets
Hood suction is not effective	Inadequate ventilation	Ensure that the kitchen is sufficiently ventilated to allow entry of fresh air
	Charcoal filters are not installed	Install charcoal filters for setting in recirculation mode
Motor is running but no airflow	Poor exhaust	Please contact Rinnai Customer Care Service
Whirring sound	Foreign object may be in contact with fan blade	Please contact Rinnai Customer Care Service
Lights are not working	Bulbs are blew out	Replace the damaged bulbs
	Bulbs are loose	Tighten the bulbs

If problem persists after the above checks, please contact Rinnai Customer Care Centre for assistance.

Please quote the model number of your appliance as shown on the rating plate attached to your equipment (Fig. 13).

For service calls under warranty, please note that it is necessary to produce your proof of purchase and valid warranty card.

**Rinnai**  
**RANGE HOOD**

MODEL : RH-C819-GB  
 TYPE : CHIMNEY  
 INPUT POWER : Lamp ( 1x7W )  
 POWER SUPPLY : 220-240V / 50Hz  
 RATED POWER : 227W

SERIAL No : \_\_\_\_\_

CIRCUIT DIAGRAM

**Fig.13**  
(For illustration purpose only.)



## Rinnai Customer Care Centres

### China | 中国

Guangzhou Rinnai Gas & Electric  
Room 2805, No.31 Jianghe Building,  
Tianshou Road, Guangzhou, China  
广州林内燃具电器有限公司  
中国广州天河区天寿路 31 号江河大厦 2805 室  
Tel 电话 : (86) 20 3821 7976  
Email 邮箱 : grrjdc@gzrinnai.com.cn  
URL 网址 : www.gzrinnai.com.cn

### Indonesia

PT. Bhakti Idola Tama  
Jl. Raya Perjuangan No.21,  
Komp. Ruko Sastra Graha No.11 -13  
Jakarta 11530  
Tel : (62) 0804-1-889-889 (Customer Care) /  
0815 112 99999(SMS Center)  
Email: customer\_bit@yahoo.com  
URL:www.rinnai.co.id

### Macau

Rinnai Appliance Service Center  
Nam Kwong Petroleum & Chemicals Co., Ltd  
Avenida do Dr. Rodrigo Rodrigues, Nam Kwong  
Building, 17/F, Macau  
Tel: (853)83911712  
Fax: (853)28330856

### Malaysia

Rinnai (M) Sdn Bhd  
D2-3-G & D2-3-1, Block D2, Pusat Perdagangan Dana 1,  
Jalan PJU 1A/46, 47301 Petaling Jaya,  
Selangor Darul Ehsan, Malaysia  
Tel : (60) 3 7832 0037 / 7832 0038 / 7832 0039  
Fax : (60) 3 7832 0036  
Toll free: 1800-88-8180  
Email: customercare@rinnai.com.my  
URL : www.rinnai.com.my

### Myanmar | မြန်မာ

Myanmar Kowa International Co., Ltd  
No.199, Ground Floor, 34th Street (Upper Block),  
Kyauktada Township, Yangon, Myanmar  
အမှတ်(၁၉၉)၊ ၃၄ လမ်း ( ) ၊  
ကျောက်တံတားမီဂျီယူ၊ ရန်ကင်းမြို့။  
Tel ဖုန်း : (95-1) 245925 / 246304 / (95-9) 7300 7773  
Fax ဖုန်း(စုံ) : (95-1) 245925  
Email အီးမေးလ် : marketing@myanmarkowa.com

### Philippines

Mitsui Industria Corporation  
10 Buenaventura St., Cor MacArthur  
Highway, Dalandan Valenzuela City,  
Philippines  
Tel : (63) 2 292 9177 / 292 9179  
Fax : (63) 2 292 8187

### Singapore

Rinnai Holdings (Pacific) Pte Ltd  
61 Ubi Road 1 #02-20 & 21  
Oxley Bizhub Singapore 408727  
Tel : (65) 6748 9478  
Fax : (65) 6745 9240  
Email : service@rinnai.sg  
URL : www.rinnai.sg

### Thailand | ประเทศไทย

Rinnai (Thailand) Co., Ltd. / Lucky Flame Co., Ltd.  
61/1 Soi Kingkaew 9, Kingkaew Rd.  
Racha Thewa, Bangphli, Samutprakarn 10540, Thailand  
บริษัท รินไน (ประเทศไทย) จำกัด  
เลขที่ 61/1 ซอยกิ่งแก้ว 9 ถนนกิ่งแก้ว ตำบลลำชำทะเล  
อำเภอบางพลี จังหวัดสมุทรปราการ  
ประเทศไทย 10540  
Tel : (66) 2 3124330-40  
Email : lucky02@luckyflame.co.th  
URL : www.luckyflame.co.th

### Vietnam | Việt Nam

Rong Viet Commerce Company Limited  
120 3/2 Street, Ward 12, District 10,  
Ho Chi Minh City, Vietnam  
Công Ty TNHH Thương Mại Ròng Việt  
120 Đường 3/2, Phường 12, Quận 10,  
TP. Hồ Chí Minh, Việt Nam  
Tel : (84) 8 3862 3409  
Fax : (84) 8 5404 1964  
Email : info@rongviet-rinnai.com  
URL : www.rongviet-rinnai.com