

INSTALLATION-GENERAL

REU-VRM2632WC / VRM3237WC

AC weatherproof external earthed power point is required within 1500 mm of the appliance.

The appliance weighs approx. **A**, depending on the wall on which it is to be mounted must be capable of supporting it and associated pipework. Ensure that suitable fixing screws or bolts are used to secure the appliance to the wall. Bracket and fixing hole locations are shown overleaf.

The top bracket has a keyhole slot so that the appliance can be positioned by hanging it on one screw, then the other screws can be secured. After determining the most suitable position, fix the appliance to the wall.

Connect hot and cold water and gas pipes. Approved valves **MUST BE FITTED** to both the cold / hot water pipes and the gas inlet. In areas where the water pressure is over 1000 kPa, a pressure limiting valve must also be fitted. the gas connection is **B**, the cold water inlet and hot water outlet connections are **C**. Locations are shown overleaf.

The appliance range can use up to **D** of gas.

IF THE GAS PIPE SIZE IS INSUFFICIENT, THE CUSTOMER WILL NOT GET THE FULL PERFORMANCE BENEFIT. An approved isolation valve **MUST BE FITTED** to the gas inlet. Connection size is **B**. This is **NOT** an indication of the size of pipe required. Check the data plate for gas inlet.

This appliance is not suitable for use as a pool heater.

Never connect an earth wire to gas supply line.

This appliance is for **OUTDOOR** use.

	VRM2632WC	VRM3237WC
A (the appliance weights)	19kg	29kg
B (gas inlet)	R3/4(20mm)	R3/4(20mm)
C (cold / hot water pipes)	R3/4(20mm)	R3/4(20mm)
D (input)	199MJ/h	250MJ/h

POSITIONING

This external model is an externally mounted, power flued appliance. **IT MUST ONLY BE FITTED OUTSIDE THE BUILDING.**

When determining a suitable position for the appliance, the length of hot water pipe runs should be taken into consideration. In principle, the appliance should be as close as possible to the most often used taps, or in a central location between taps, showers etc.

See diagram overleaf for position of gas, water and power connections.

The location of the flue terminal must comply with the clearances shown in the following diagram.

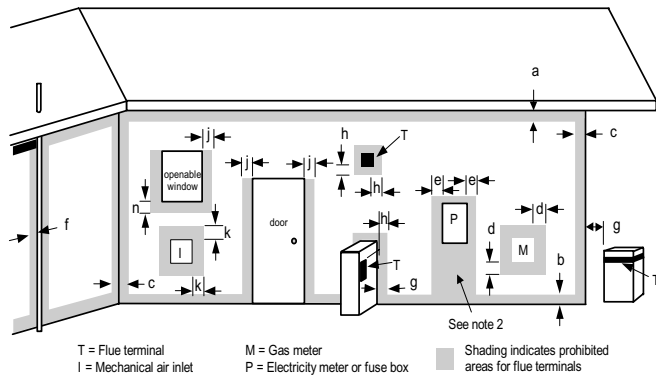

Ref.	Item	Min. clearances (mm)
		Fan assisted
a	Below eaves, balconies and other projections: • Appliances over 50 MJ/h input	300
b	From the ground, above a balcony or other surface †	300
c	From a return wall or external corner †	300
d	From a gas meter (M)	1000
e	From an electricity meter or fuse box (P)	500
f	From a drain pipe or soil pipe	75
g	Horizontally from any building structure † or obstruction facing a terminal	500
h	From any other flue terminal, cowl, or combustion air intake †	300
j	Horizontally from an openable window, door, non-mechanical air inlet, or any other opening into a building with the exception of sub-floor ventilation: • Appliances up to 200 MJ/h input • Appliances over 200 MJ/h input up to 250 MJ/h input † • Appliances over 250 MJ/h input † • All fan-assisted flue appliances, in the direction of discharge	300 500 1500 1500
k	From a mechanical air inlet, including a spa blower	1000
n	Vertically below an openable window, non-mechanical air inlet, or any other opening into a building with the exception of sub-floor ventilation: • Space heaters up to 50 MJ/h input • Other appliances up to 50 MJ/h input • Appliances over 50 MJ/h input and up to 150 MJ/h input • Appliances over 150 MJ/h input	150 500 1000 1500

† Unless appliance is certified for closer installation

note 1. All distance are measured to the nearest part of the terminal.
note 2. Prohibited Area below electricity meter or fuse box extends to ground level.

TESTING AND COMMISSIONING

- Before final connection of the water heater purge gas, hot water and cold water supply lines. Swarf in either the gas or water supplies may cause damage.
- Turn on gas and cold water supplies.
- Test for water leaks and gas escapes near the unit.
- Isolate gas supply. Remove test point screw located on the gas inlet connection and attach pressure gauge.
- Turn the power 'on' at the power point socket and turn on gas.
- Open all available hot water taps. (**CAUTION:** Ensure building occupants do not have access to hot water outlets during this procedure.)
- Operate **ALL** other gas appliances at their maximum gas rate, in accordance with manufacturers instructions.
- With all gas appliances in operation at maximum gas rate, check the inlet gas pressure. If the pressure is lower, the gas supply is inadequate and the appliance will not operate to specification. It is the Installers responsibility to check the gas meter, service regulator and pipe work for correct operation/sizing and rectify as required. **Note** that the gas regulator on the appliance is electronically controlled and factory pre-set. Under normal circumstances it **DOES NOT** need adjustment during installation.
- Close hot water taps including the shower.
- Inspect and clean the strainer located on the cold water inlet connection. This procedure may need to be repeated to ensure the strainer remains clear, especially on new installations.
- If Temperature Controllers are fitted, it is necessary to test their operation through the complete range of functions. (Refer to the 'How to use your Water Heater' booklet.)
- Confirm the hot water delivery temperature(s) using a thermometer. If controllers are fitted, ensure temperatures exceeding 50° C cannot be selected on bathroom or ensuite controllers.
- After testing is completed, explain to the householder the functions and operation of the water heater and temperature controllers (if fitted).

DIMENSIONS (VRM2632WC)

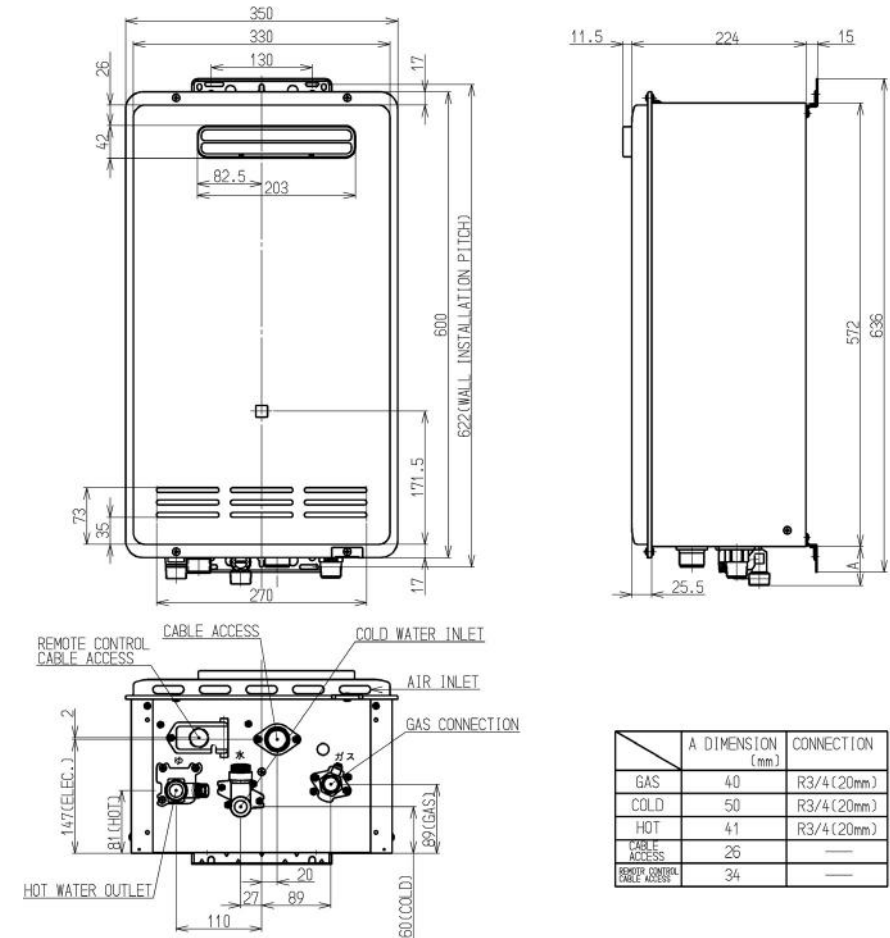

DIMENSIONS (VRM3237WC)

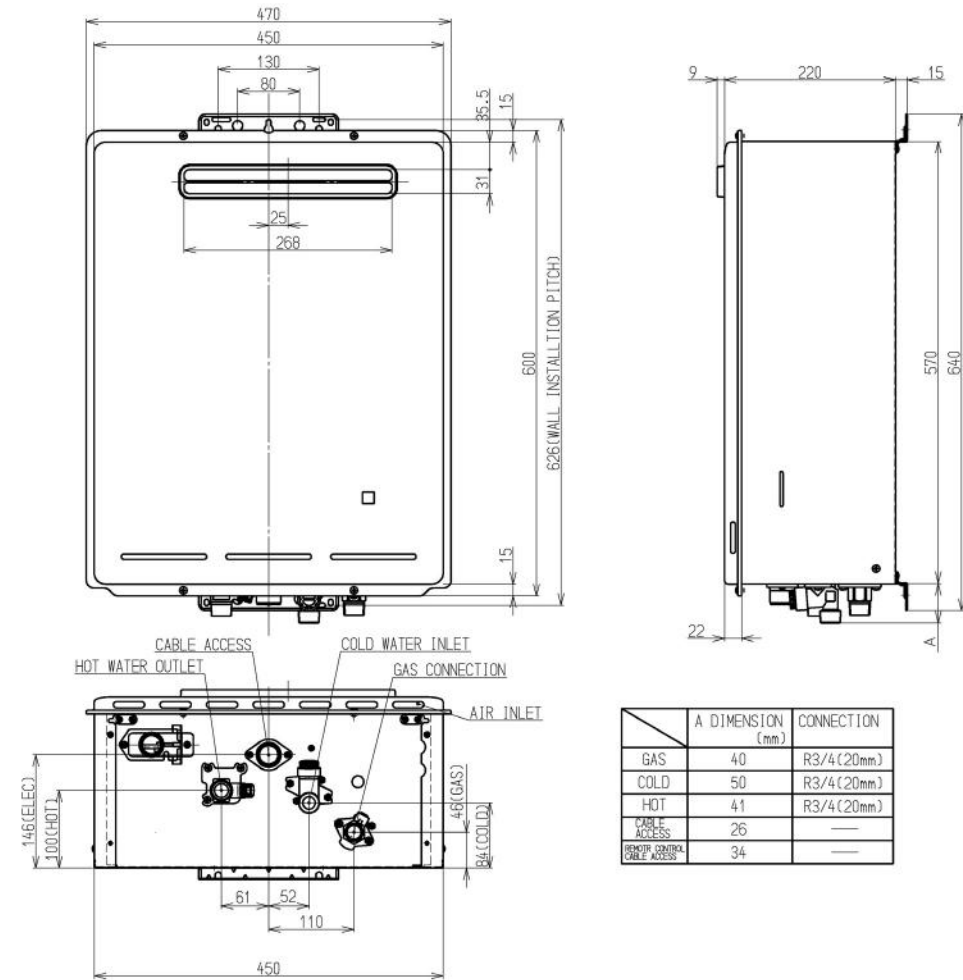

REU-VRM2632WC / VRM3237WC

GAS PRESSURE SETTING

WARNING DURING PRESSURE TESTING OF THE CONSUMER PIPING ENSURE GAS COCK SITUATED BEFORE UNIT IS SHUT-OFF. FAILURE TO DO SO MAY RESULT IN SERIOUS DAMAGE TO THE APPLIANCE AND POSSIBLE INJURY.

The regulator on the Infinity is electronically controlled and factory pre-set. Under normal circumstances it does not require adjustment during installation. Perform this procedure only if the unit is not operating correctly and all other possible causes for incorrect operation have been eliminated.

1. Turn 'OFF' the gas supply.

2. Turn 'OFF' power supply.

3. Remove the front cover from the appliance.

4. Check gas type switches (fig. 1) are in the correct position (No.1 switch of Dip.SW2 'ON' = NG, 'OFF' = LPG).

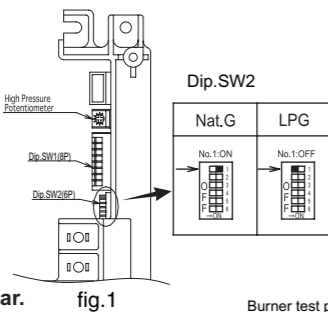

Note: 'ON' towards front, 'OFF' towards rear.

5. Attach pressure gauge to burner test point, located on the gas control. (fig. 2)

6. Turn 'ON' the gas supply.

7. Turn 'ON' power supply.

8. If remote controllers are fitted, turn the unit 'ON' at the kitchen controller, select the maximum delivery temperature and open a hot water tap fully. (**CAUTION:** Ensure building occupants do not have access to hot water outlets during this procedure.)

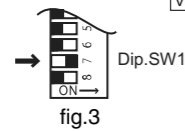
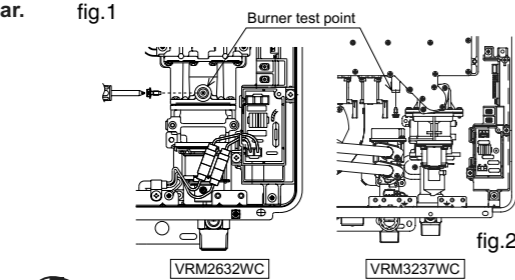

9. Set the appliance to 'Forced Low' combustion by setting No. 7 switch of the Dip.SW1 set of dip switches to 'ON'. (fig. 3)

	NG	LPG
VRM2632WC	0.14	0.23
VRM3237WC	0.18	0.23

Table 1 Pressure Setting LOW

10. Check the burner test point pressure.

11. Remove rubber access plug and adjust the regulator screw on the modulating valve (fig. 4) as required to the pressure. (Table 1) Replace rubber access plug.



12. Set the appliance to 'Forced High' combustion by setting both No. 7 and No. 8 switches of the bottom Dip.SW1 set to 'ON'. (fig. 5) Ensure maximum water flow.

	NG	LPG
VRM2632WC	0.73	1.20
VRM3237WC	0.80	0.98

Table 2 Pressure Setting HIGH

13. Check the burner test point pressure.

14. Adjust the high pressure Potentiometer (POT) on the Printed Circuit Board (PCB) as required to the pressure shown Table 2.

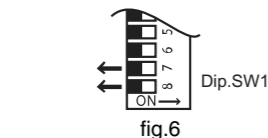

15. **IMPORTANT:** Set No. 7 and 8 switches on the bottom (Dip.SW1) set of switches to 'OFF' to return the appliance to 'Normal' combustion. (fig. 6)

16. Close hot water tap.

17. Turn OFF the gas supply and power supply.

18. Remove pressure gauge, and replace sealing screw.

19. Turn 'ON' the gas supply and power supply.

20. Operate unit and check for gas leaks at test point.

21. Replace the front cover of the appliance.

COLOUR CODING

W	: White
Bk	: Black
Br	: Brown
R	: Red
B	: Blue
Y	: Yellow
O	: Orange
Gr	: Green
Gy	: Grey
Pu	: Purple

WIRING DIAGRAM

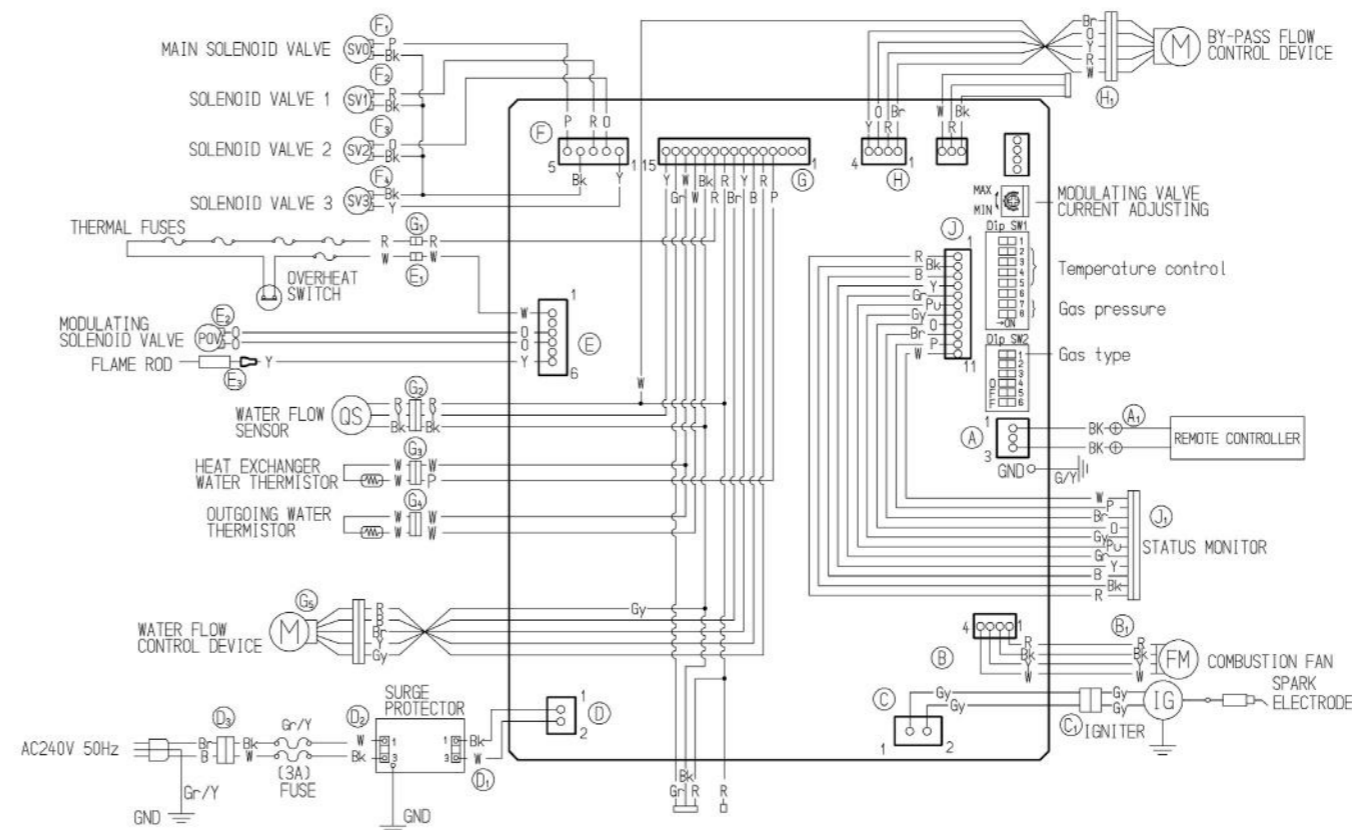

DIAGNOSTIC POINTS

ROW No.	COMPONENT	MEASUREMENT POINT CN	WIRE COLOUR	NORMAL VALUE	A NOTE
①	SURGE PROTECTOR	D ₁	W-Bk	AC207~264V	
②	WATER FLOW CONTROL DEVICE	G ₅	R-B	DC11~13V	OPERATE ELECTRICITY
			Gy-O	DC11~13V	CONTROL ELECTRICITY
③	BY-PASS FLOW CONTROL DEVICE	H ₁	Br-W	DC12V(OPERATING DC2~6V)	
			O-W		
④	REMOTE CONTROL	A ₁	Y-W	15~35 Ω	
			R-W GND		
⑤	WATER FLOW SENSOR	G ₂	R-Bk	DC11~13V	
			Y-Bk GND	DC4~7V(PULSE 17~460Hz)	
⑥	COMBUSTION FAN	B ₁	R-Bk	DC6~45V	
			Y-Bk	DC11~13V	
			W-Bk GND	DC6~45V (33~400Hz)	
⑦	FLAME ROD	E ₃	Y-BODY EARTH	AC5~150V	AFTER IGNITION
			Y-FLAME ROD	OVER DC1 μA	FLAME CONDITION
⑧	MODULATING VALVE	E ₂	O-O	DC2~15V	
				67~81 Ω	
⑨	OUTGOING THERMISTOR	G ₄	W-W	15°C: 11.4~14.0kΩ	
				30°C: 6.4~7.8kΩ	
				45°C: 3.6~4.5kΩ	
				60°C: 2.2~2.7kΩ	
⑩	HEAT EXCHANGER OUTGOING THERMISTOR	G ₃	W-W	105°C: 0.6~0.8kΩ	
⑫	THERMAL FUSE	E ₁	G ₁		
			R-W	BELOW 1 Ω	
⑬	IGNITER	C ₁	Gy-Gy	AC207~264V	
⑭	MAIN SOLENOID VALVE	F ₁	P-Bk	DC11~13V 37~43 Ω	
⑮	SOLENOID VALVE 1	F ₂	R-Bk	DC11~13V 37~43 Ω	
⑯	SOLENOID VALVE 2	F ₃	O-Bk	DC11~13V 37~43 Ω	
⑰	SOLENOID VALVE 3	F ₄	Y-Bk	DC11~13V 35~41 Ω	



080 00012 31518 7

REU-VRM2632WC-ASN
REU-VRM3237WC-ASN

U298-902 (00)