

Rinnai

Operation / Installation Manual

操作 / 安装说明

Vitroc ceramic Hob

红外炉

RB-3012E-CB / RB-3012E-ZB

RB-6014E-CB / RB-6014E-ZB

RB-6024E-CB / RB-6024E-ZB

RB-7013E-CB / RB-7013E-ZB

Rinnai Corporation

TABLE OF CONTENTS

English

Page 01 - 12

CONTENTS

Safety Instructions -----	1
Technical Data -----	2
Guide To The Appliance -----	3
Helpful Hints and Tips -----	5
Operating Instructions -----	6
Maintenance and Care -----	7
Troubleshoot-----	8
Installation Instructions -----	9
Electrical Connection -----	11



IMPORTANT

Please paste the serial number labels enclosed with the packaging on your warranty card to register your product warranty. Please contact your local Rinnai Customer Care Centre should you require further assistance.

SAFETY INSTRUCTIONS

Please read this user manual thoroughly before attempting to use this appliance for the first time. This manual contains important information on safe installation, use and care of the appliance. Keep these instructions for reference and pass them on to future user.

Unpacking

- Do not use the appliance if there are obvious signs of transportation damage.
- If the power supply cord is damaged, it must be replaced by the manufacturer, its service agent or qualified technician to avoid hazard.
- Please ensure that young children do not play with plastic bag packaging.

For the user

- This appliance is for home food preparation only. Do not use the appliance other than its specific purpose.
- This appliance is not intended for use by young children or infirm persons without supervision.
- Do not leave the appliance unattended during operation.
- Do not use the appliance as a work surface or as a storage surface
- It is dangerous to modify any part of this appliance. Tampering with electrical connections or mechanical parts can cause operation faults and may put the user at risk.
- Installation and repair should only be attempted by qualified technician.
- Flammable or combustible objects such as aerosol cans should not be stored near the appliance.
- Accessible parts may become hot during use. Keep small children away from the appliance.
- Do not heat unopened food containers as build-up of pressure may cause container to burst and result in injury.
- Do not use aluminium foil, aluminium liners, aluminium containers on the appliance.
- Never leave appliance unattended at high heat settings. Boil-over causes smoking and greasy

spillovers may ignite.

- Switch off the cooking zone after each use.
- Keep away plastic or aluminium objects or products with high sugar content from the appliance. If placed on hob surface while still hot, they may cause damage to the hob surface.
- Do not use if appliance is faulty or cooktop is cracked to avoid possibility of electric shock. Contact a qualified technician immediately for repair and service.
- To avoid damaging the hob surface and cookware, ensure that cookware do not boil dry.
- Clean the appliance with caution. If a wet sponge or cloth is used to wipe spills on a hot cooking area, be careful to avoid steam burn or marks on the hob surface.
- Never use steam cleaners or pressure cleaners on the appliance.
- Always make sure that the pan handles are turned inwards to avoid accidental burns.
- Always disconnect the unit from the power supply before carrying out any cleaning or maintenance work on the appliance
- Ensure that power supply cord of other electrical appliances do not come into contact with the hot parts of the hob.
- Multiple plugs and extension cables must not be used. Overloading is dangerous and may cause fire hazard.

Disposal

- This appliance and its packaging are environmentally friendly and recyclable. Please help us to care for the environment by disposing the packaging in a proper manner and recycling any old appliances.
- Before disposing an old appliance, disconnect it from the power supply and cut the power supply cord to prevent hazards.

The manufacturer will not be held liable for any damages resulting from improper installation nor failure to adopt proper safety measures during installation and operational use of the appliance.

TECHNICAL DATA

Model	RB-3012E-CB RB-3012E-ZB	RB-6014E-CB RB-6014E-ZB
Voltage	220-240V	220-240V
Frequency	50/60Hz	50/60Hz
No. of Cooking Zones	2	4
Power of Cooking Zones	Front: 1.8kW Back: 1.2kW	Front left: 1.8kW Front right: 1.2kW Rear left: 1.2kW Rear right: 1.8kW
Total Power	3000W	6000W
Appliance Dimension	310*520*50mm	590*520*50mm
Cut-out Dimension	270*490mm	560*490mm

Model	RB-6024E-CB RB-6024E-ZB	RB-7013E-CB RB-7013E-ZB
Voltage	220-240V	220-240V
Frequency	50/60Hz	50/60Hz
No. of Cooking Zones	4	3
Power of Cooking Zones	Front left: 1.1/2.2kW Front right: 1.2kW Rear left: 1.2kW Rear right: 1.8kW	Left:1.1/2.2kW Middle:1.2kW Right:1.8kW
Total Power	6400W	4100W
Appliance Dimension	590*520*50mm	710*410*50mm
Cut-out Dimension	560*490mm	680 * 380mm

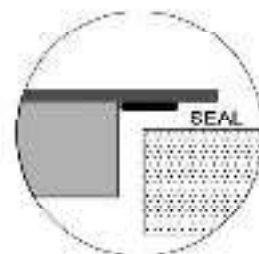
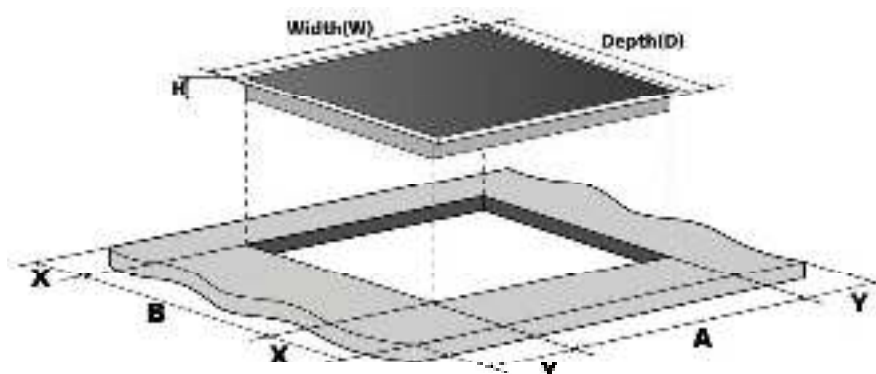

Model No.	A(mm)	B(mm)	W(mm)	D(mm)	H(mm)	X(mm)	Y(mm)
RB-3012E-CB RB-3012E-ZB	270	490	310	520	50	50	60
RB-6014E-CB RB-6014E-ZB	560	490	590	520	50	50	60
RB-6024E-CB RB-6024E-ZB	560	490	590	520	50	50	60
RB-7013E-CB RB-7013E-ZB	680	380	710	410	50	50	60

Measurements in mm.

Min. 50mm from hob cut-out to back wall.

Min. 60mm from hob cut-out to side wall.

Min. 70mm from the bench top with a fitted drawer underneath.

Min. 55mm from the bench top with a fitted oven underneath.

Min. 30mm from back cabinet for ventilation gap.

GUIDE TO THE APPLIANCE

RB-3012E-CB / RB-3012E-ZB

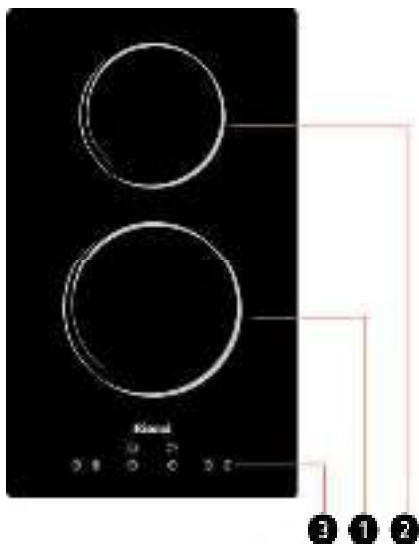

- 1. 1800W(Φ 200mm)
- 2. 1200W(Φ 165mm)
- 3. Control panel

RB-7013E-CB / RB-7013E-ZB

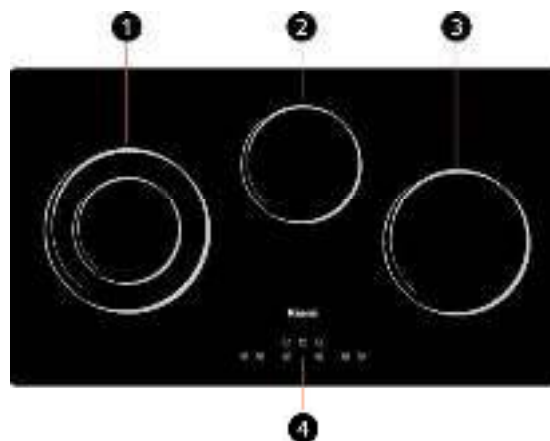

- 1. Dual Zone 1100W/2200W (Φ 140mm/ Φ 230mm)
- 2. 1200W(Φ 165mm)
- 3. 1800W(Φ 200mm)
- 4. Control panel

RB-6014E-CB / RB-6014E-ZB



- 1. 1800W(Φ 200mm)
- 2. 1200W(Φ 165mm)
- 3. 1800W(Φ 200mm)
- 4. 1200W(Φ 165mm)
- 5. Control panel

RB-6024E-CB / RB-6024E-ZB

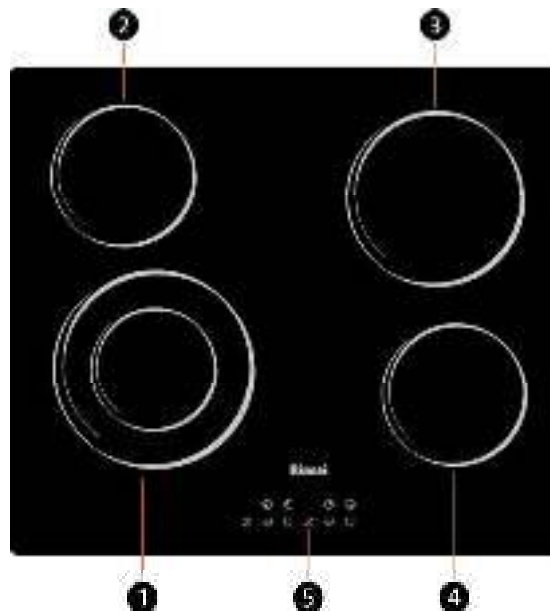

- 1. Dual Zone 1100W/2200W (Φ 140mm/ Φ 230mm)
- 2. 1200W(Φ 165mm)
- 3. 1800W(Φ 200mm)
- 4. 1200W(Φ 165mm)
- 5. Control panel

CONTROL PANEL

RB-3012E-CB / RB-3012E-ZB

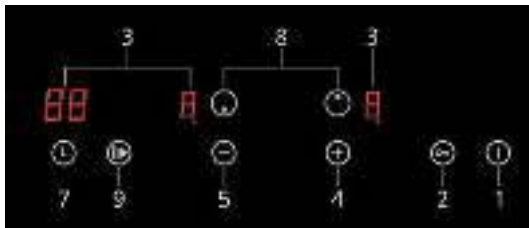

RB-7013E-CB / RB-7013E-ZB

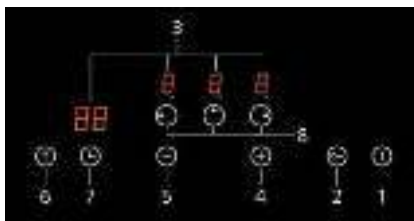

RB-6014E-CB / RB-6014E-ZB

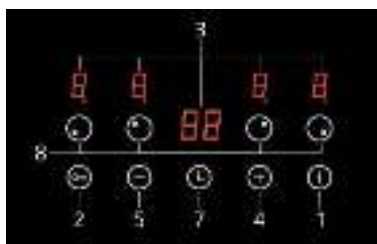

RB-6024E-CB / RB-6024E-ZB



1. ON/OFF key
2. Child lock
3. Power level indicator / Timer indicator
4. Power level selector ("+" to increase level)
5. Power level selector ("- " to decrease level)
6. Dual zone
7. Timer key
8. Cooking zone selector
9. Stop & Go function

HELPFUL HINTS AND TIPS

Practical Cooking Advice

This appliance is programmed with 9 power levels.

The following power levels should be taken as a guide only. A higher power level setting is required when using deep pans, cooking large food quantities, or cooking without a lid. Select a lower power setting for smaller food quantities.

Power level range	Cooking mode	Suitable for
1 - 2	<ul style="list-style-type: none"> Keeping warm Melting 	<ul style="list-style-type: none"> Keeping cooked foods warm, warming small quantities of liquid Melting butter, chocolate, sauces, thickening sauces
2 - 3	<ul style="list-style-type: none"> Simmering Reheating 	<ul style="list-style-type: none"> Soup simmering Reheating ready-cooked meals
3 - 4	<ul style="list-style-type: none"> Steaming Braising Light frying 	<ul style="list-style-type: none"> Steaming vegetables, fish Braising meat, fish, vegetables etc Lightly fried eggs, omelettes
4 - 5	<ul style="list-style-type: none"> Boiling 	<ul style="list-style-type: none"> Cooking dumplings, potatoes Cooking larger quantities of food, stews and soups Making porridge
6 - 7	<ul style="list-style-type: none"> Gentle frying 	<ul style="list-style-type: none"> Frying sausages, meat, vegetables etc Crepes, frying pancakes etc
7 - 8	<ul style="list-style-type: none"> Heavy frying 	<ul style="list-style-type: none"> Cooking on a high flame and browning(roasts, steaks, fillets etc)
8 - 9	<ul style="list-style-type: none"> Deep frying, searing Boiling 	<ul style="list-style-type: none"> Deep frying Chips, searing meat etc Boiling large quantities of water, cooking pasta



Environmental Tips

- Switch off the cooking zones before the end of cooking time to take advantage of residual heat.
- Residual heat can be used for keeping food warm.
- Place lids on the cookware whenever possible to minimize heat loss.
- Cookware base size and cooking zone should be of same size for better heat efficiency.
- Select a smaller cookware size if cooking small food quantities. A smaller pan size uses less energy than a larger pan with small food quantities.
- Lift cookware into positions on the hob. Sliding them can cause scuffs and scratches on the hob surface.

USING FOR THE FIRST TIME

New appliances have a slight smell on first use. The unpleasant odour that is often detected during initial use is caused by the burning of protective substances used during the manufacturing process. The odour emitted does not indicate a faulty appliance nor is harmful to health.

Remove packaging material

Ensure that all packaging material is removed before using the hob for the first time.

Using the Touch Controls



- The controls respond to touch, so you don't need to apply any pressure.
- Use the ball of your finger, not its tip.
- You will hear a beep each time a touch is registered.
- Make sure the controls are always clean, dry, and that there is no object (e.g. a utensil or a cloth) covering them. Even a thin film of water may make the controls difficult to operate.





OPERATING INSTRUCTIONS



Switching on/off the hob

The hob must be switched on before any of the cooking zones can be used.

- To switch on the hob, press ON/OFF key . A 'signal' sounds and power indicator light is displayed (on standby mode). If no function is selected within 1 minute after switching on, the hob automatically switches itself off for safety reasons.
- To switch off the hob, touch ON/OFF key  and power indicator goes off.

Switching on a single cooking zone

Each cooking zone is controlled by a cooking zone selector and power level select key  and .

- To start operating a cooking zone, touch the corresponding zone selector key (i.e. ).
- Set the desired power level (between 0~9) for the selected cooking zone using  or  keys. The default power level setting is level '5'.

Switching off the cooking zones

- To switch off a cooking zone, use the corresponding control key and progressively press the  key until the hob is switched off.

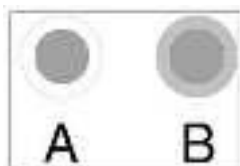

Switching on the dual cooking zone

The dual zone function means that there is two cooking zones, includes the central zone and the outer zone. You can use the central zone (**A**) independently or both zones (**B**) at the same time.





When you touch the cooking zone selector, it will switch on the central zone only.

To activate the outer zone:

- Press the zone selector key (i.e. ).
- Press dual zone key , display will show '='.

To deactivate the dual outer zone:

- Choose the zone with dual zone active (i.e. ).
- Press dual zone key  to switch off the outer cooking zone, and choose the level you want to set.

Tips:

Power Sharing between cooking zones (FOR RB7013E-CB/ZB ONLY)



If using dual zone function, the power management shares the maximum available power between three cooking zones.

As soon as the outer cooking zone is turned on, the

power management will not allow all both zones to operate at full power but will alternate power between the dual zone or middle cooking zone. The change will be visible on both displays. The last command given to a cooking zone takes priority on the power setting.

Child Lock function

The child lock function prevents unintentional changing of settings. Any operation on the control functions will not work until the hob is unlocked.

- To activate, press the lock key . The display on timer key shows 'Lo'.
- To deactivate, press and hold the lock key  for 3 seconds. The 'Lo' goes off and hob is unlocked.

 When the hob is in lock mode, all keys are disable except ON/OFF. You can always turn the hob off with the ON/OFF key in an emergency, but you shall unlock the hob first in the next operation.

Minute Minder:

You can use the timer as a minute minder while the cooking zones do not operate

To operate:

- Turn on the hob, using the on/off key.
- Press the timer key to operate this function
- Press on the power level key selector to set the time (00 to 99 minutes)
- When the time has ended the buzzer will beep for 30 seconds and display will shows " - "
- To deactivate the minute minder, press the timer key  to adjust the time to 00.







Timer



Count Down Timer

Use the countdown timer to set how long you want the cooking zone to operate



Set the countdown timer only after you have selected the cooking zone

 The selection of timer function is only possible when the cooking zones are active and the heat setting is set

- To set the cooking zone press on the corresponding zone selector key (i.e. ) that you wish to set the timer.
- To activate the countdown timer, press the timer key  to operate this function
- Press  or  of the power level key selector to set the desired minutes (0 to 9). Press the timer key  again, Press  or  of the power level key selector to set the desired tenths (0 to 9). The indicator of the cooking zone starts to blink.

- To see the remaining time press on the corresponding zone selector key, the display will show the remaining time
- When the time is set, the countdown will begin and the display will show the remaining time. There will be a red dot in the right bottom corner of the power display to indicate which are the cooking zones is having this function turn on
- When the time countdown function comes to an end the corresponding zone will be switched off automatically.
- To deactivate the countdown time, press on the corresponding zone selector key (i.e. )
- Press the timer key selector  to adjust the time to 00. The indicator of the cooking zone goes out.

Stop & Go Function (For RB-3012E-CB / RB-3012E-ZB)

- Select the pause control , all the heating zones stop working, all the zone indication shows "H"
- Touch the pause control  again, all the heating zones will revert to its original setting

NOTE: If you don't cancel the stop & go function within 30 minutes, the hob will automatically switch off.

Residual heat warning

When switching off a cooking zone, if the temperature of the zone is too warm to be touched, the display will show "H".

Avoid touching the hob surface over the cooking area. Please pay special attention to children.

"H" is turned off when the cooking zone temperature drops below a present temperature.

Automatic switch off

This hob is equipped with a safety switch which automatically switches off the cooking zones after they have been in continuous operation at different power levels.

Suppose the front cooking zone is set to level 8, the cooking zone will switch off after 2 hours of continuous operation, while the back cooking zone set to level 2 will switch off after 6 hours of continuous operation.

Power levels	Cooking zone switches off after
1, 2, 3	8 hours
4, 5, 6	4 hours
7, 8, 9	2 hours

Useful Tip

- Always place cookware on the cooking zone before switching on the appliance.
- Take care to keep the control panel clean and never place the pans on the control panel sensors. The electronic unit beneath it could be damaged.

MAINTENANCE AND CARE

WARNING:

Disconnect the power supply cord before carrying out any cleaning or maintenance activities.

Cleaning the appliance

The appliance should be cleaned regularly, preferably after each use.

- Do not use abrasive or corrosive cleaning agents as these may scratch the surface.
- Avoid using hard, abrasive brushes or sponges.
- Never use steam cleaners or pressure cleaners on the appliance.
- Clean the hob with a damp soft cloth using and mild detergent or suitable ceramic and stainless steel hob cleaner. Do not apply cleaner when the hob is still hot as this could result in marking on the surface. Wipe dry with a soft dry cloth. Ensure that all cleaner residues are removed as residues can burn onto the appliance next time it is used and could cause possible damage to the surface.

- To remove more stubborn dirt, or if any sugary deposits are melted on the hob during cooking, remove the spills as soon as possible with a special scraper while the surface is still hot. Allow the appliance to cool down, and then clean the hob as described above.
- *Scraper for glass ceramic can be purchased from specialized shops.

Useful Tips:

- Allow the appliance to cool down to room temperature before cleaning. Use a soft cloth to dry surfaces that have been cleaned with water to avoid water marks.
- To avoid food or liquid residues forming deposits on the appliance surface, remove stains or spills as soon as possible without waiting for the appliance to cool.

TROUBLESHOOT

The hob does not work

- Check that the main switch is turned on and any plug or power cable is properly inserted in the electrical outlet.

The hob gives off a smell when used for the first time

- This is a normal occurrence. Please read 'Using for the First time' in this manual.

The cooking zones not switching on or are not functioning

- Check if more than 10 seconds have passed since the appliance was switched on.

INSTALLATION INSTRUCTIONS

CAUTION

- This appliance shall only be serviced by authorized personnel.
- This appliance is to be installed only by an authorized person according to the current local regulations and in observation of the manufacturer's instructions.
- Incorrect installation, for which the manufacturer accepts no responsibility, may cause personal injury or damage.
- Always disconnect the cooktop from mains power supply before carrying out any maintenance operations or repairs.

WARNING

- We would point out that the adhesive which bonds the plastic laminate to the furniture must withstand temperatures not less than 150 °C to avoid delamination.
- The appliance must be housed in heat resistant units.
- The walls of the units must be capable of resisting temperatures of 75 °C above room temperature.

The cooktop can be built into a working surface 30 to 40 mm thick and 600 mm deep.

In order to install the induction hob into the kitchen fixture, a hole with the dimensions shown in fig.4.1 has to be made, keeping in consideration of the following:

- The cooktop shall not be installed directly above a dishwasher, fridge, freezer, washing machine or clothes dryer, as the humidity may damage the cooktop electronics.
- If the cooktop is installed above an oven, the oven shall be provided with cooling fan. The two electrical supply with independent connections.

IMPORTANT WARNING! This cooktop requires adequate supply of fresh, cool air to fully function. The base of the cooktop must have direct unrestricted ventilation to the room where the cooktop is installed. Follow the requirements of figure 4.3

- The ceramic hob must be kept no less than 60 mm away from any side wall.
- The rear wall must be at least 50 mm from the induction hob.
- There must be a distance of at least 650 mm between the hob and any wall cupboard or extractor hood positioned immediately above (see fig. 4.2)
- The coatings of the walls of the unit or appliances near the cooktop must be heat resistant.

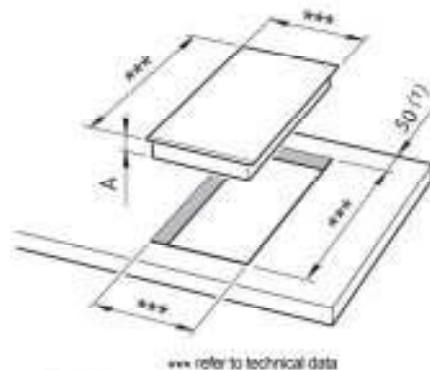

Fig. 4.1

*** refer to technical data

A	50mm	from the top of countertop to bottom metal cover
	68mm	from the top of countertop to terminal block

at least 50 mm between the back side of the cut-out and the back of the countertop

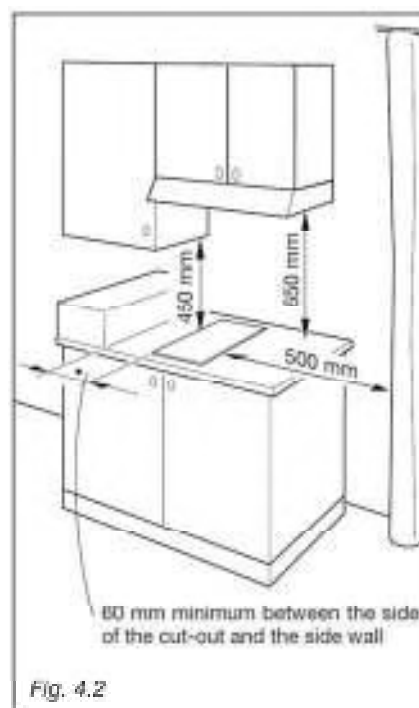

Fig. 4.2

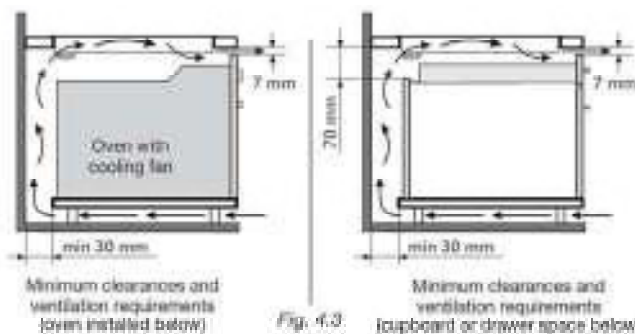

Fig. 4.3

FASTENING THE COOKTOP

Each cooktop is supplied with a set of tabs and screws to fasten it on units with a working surface from 3 to 4 cm deep.

The kit includes 4 tabs A and 4 self-threading screws B (fig. 4.4)

- Cut the unit
- Turn the hob upside down and rest the glass side on a cloth.
- Spread the seal C around the edge of the hob(fig. 4.5)
- Put tabs A into the mountings; only tighten screws B a few turns.
- Make sure that the tabs are mounted correctly as shown in figure 4.4
- Put the cooktop into the hole cut into the unit and position it correctly.
- Put tabs A into place, tooth D of the tabs should go into the hole.
- Tighten screws B until the cooktop is completely secured.
- Using a sharp tool cut off the part of gasket C which protrudes from the cooktop. Take care not to damage the workbench.

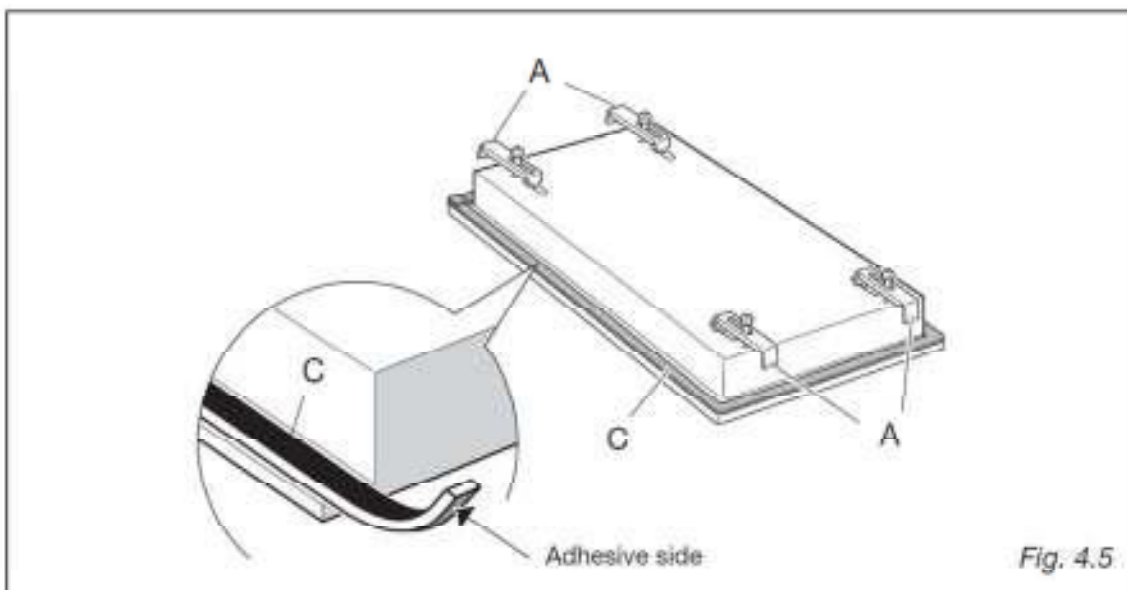
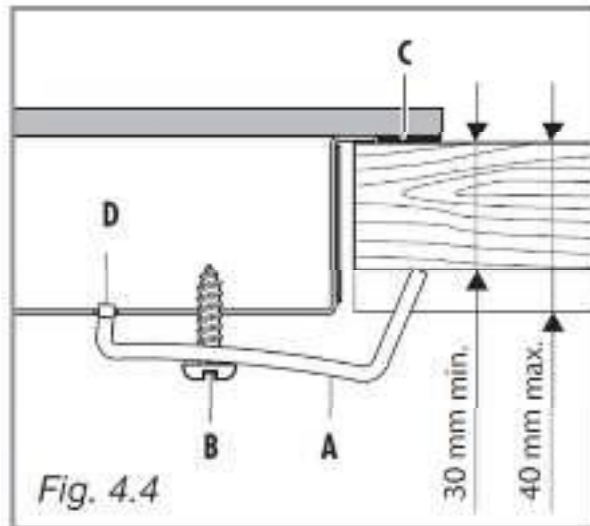

ELECTRICAL CONNECTION

IMPORTANT: Installation must be carried out according to the manufacturer's instructions. Incorrect installation may cause harm and damage to people, animals or property, for which the manufacturer accepts no responsibility. Before carrying out any work on the electrical section of the appliance, it must be disconnected from the mains. Connection to a good earth wiring system is absolutely essential. The manufacturer accepts no responsibility for any inconvenience caused by failure to comply with this rule.

ELECTRICAL REQUIREMENTS

- Connection to the electric power supply must be carried out by a qualified technician and following the appropriate safety regulations.
- The appliance must be connected to the mains checking that the voltage corresponds to the value given in the rating plate and that the electrical cable sections can withstand the load specified on the plate.
- If the hob is supplied without plug, fit a standard device which is suitable for the power absorbed by the appliance and in conformity with the local rules in force.
- A suitable isolating switch providing full disconnection from the mains power supply shall be incorporated in the permanent wiring, mounted and positioned to comply with the local wiring rules and regulations. The isolating switch must be of an approved type and provide a 3 mm air gap contact separation in all poles.
- The power supply cable must not touch the hot parts and must be positioned so that it does not exceed 50 °C above ambient.
- Once the appliance has been installed, the power switch must always be in an accessible position.

N.B. For connections to the mains power supply, never use adaptors, reductions or multiple power points as these may overheat and catch fire.

In the event that installation should require modifications to the mains supply wiring system, it is recommended that a qualified technician be called to carry out substitution.

The technician will also have to verify that the cross-section of the electric cables on the power point match the appliance's power rating.

If the hob surface is cracked disconnect the appliance from the mains and contact the after-sales service.

Replacing the power cord must be done by a qualified electrician in accordance with the instructions supplied by the manufacturer and in compliance with established electrical regulation.

 Descriptions and illustrations in this booklet are given as simply indicative. The manufacturer reserves the right, considering the characteristics of the models described here, at any time and without notice, to make eventual necessary modifications for their construction or for commercial needs.

WIRING DIAGRAM

For Below Model Only

RB-6014E-CB / RB-6014E-ZB

RB-6024E-CB / RB-6024E-ZB

RB-7013E-CB / RB-7013E-ZB

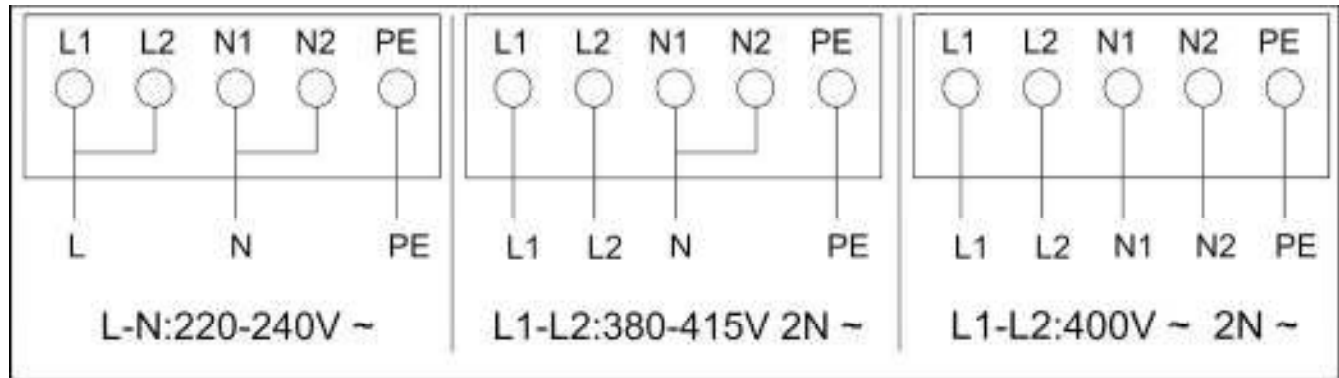

Rinnai Customer Care Centres

China | 中国

Guangzhou Rinnai Gas & Electric
Room 2805, No.31 Jianghe Building,
Tianshou Road, Guangzhou, China
广州林内燃具电器有限公司
中国广州天河区天寿路 31 号江河大厦 2805 室
Tel 电话 : (86) 20 3821 7976
Email 邮箱 : grrjdg@gzrinnai.com.cn
URL 网址 : www.gzrinnai.com.cn

Indonesia

PT. Bhakti Idola Tama
Jl. Raya Perjuangan No.21,
Komp. Ruko Sastra Graha No.11 -13
Jakarta 11530
Tel : (62) 0804 1 889 889 (Customer care) /
0815 112 99999 (SMS Center)
Email : customercare_bit@yahoo.com
URL : www.rinnai.co.id

Macau | 澳門

Rinnai Appliance Service Center
Edificio Industrial 3 andar F.A da Zona Macau
林内爐具服務中心
澳門青洲跨境工業大廈 3樓 F座
Phone 电话 : (853) 2852 7799
Fax 传真 : (853) 2827 0572
URL 网址 : www.rinnai.com.hk/mo

Malaysia

Rinnai (M) Sdn Bhd
D2-3-G & D2-3-1, Block D2, Pusat Perdagangan Dana 1,
Jalan PJU 1A/46, 47301 Petaling Jaya,
Selangor Darul Ehsan, Malaysia
Tel : (60) 3 7832 0037 / 7832 0038 / 7832 0039
Fax : (60) 3 7832 0036
Toll free: 1800-88-8180
Email: customercare@rinnai.com.my
URL : www.rinnai.com.my

Myanmar | မြန်မာ

Myanmar Kowa International Co., Ltd
No.199, Ground Floor, 34th Street (Upper Block),
Kyauktada Township, Yangon, Myanmar
အမှတ် (၁၉၉)၊ ၃၄ လမ်း (အပေါ်ဘလောက်)၊
ကျောက်တံတားမြို့နယ်၊ ရန်ကင်းမြို့။
Tel ဖုန်း : (95-1) 245925 / 246304 / (95-9) 7300 7773
Fax ဖုန်း : (95-1) 245925
Email အီးမေးလ် : marketing@myanmarkowa.com

Philippines

Mitsui Industria Corporation
10 Buenaventura St., Cor MacArthur
Highway, Dalandan Valenzuela City,
Philippines
Tel : (63) 2 292 9177 / 292 9179
Fax : (63) 2 292 8187

Singapore

Rinnai Holdings (Pacific) Pte Ltd
61 Ubi Road 1, Unit 02-20 & 21
Oxley Bizhub 1 Singapore 408727
Tel : (65) 6748 9478
Fax : (65) 6745 9240
Email : service@rinnai.sg
URL : www.rinnai.sg

Thailand | ประเทศไทย

Rinnai (Thailand) Co., Ltd.
61/1 Soi Kingkaew 9, Kingkaew Rd.
Racha Thewa, Bangphli, Samutprakarn 10540, Thailand
บริษัท รินไน (ประเทศไทย) จำกัด
เลขที่ 61/1 ซอยกิ่งแก้ว 9 ถนนกิ่งแก้ว ตำบลราชาเทวะ
อำเภอบางพลี จังหวัดสมุทรปราการ
ประเทศไทย 10540
Tel : (66) 2 3124330-40
Email : lucky02@luckyflame.co.th
URL : www.luckyflame.co.th

Vietnam | Việt Nam

Rong Viet Commerce Company Limited
120 3/2 Street, Ward 12, District 10,
Ho Chi Minh City, Vietnam
Công Ty TNHH Thương Mại Rồng Việt
120 Đường 3/2, Phường 12, Quận 10,
TP. Hồ Chí Minh, Việt Nam
Tel : (84) 8 3862 3409
Fax : (84) 8 5404 1964
Email : info@rongviet-rinnai.com
URL : www.rongviet-rinnai.com