

Rinnai

U/S/E/R/ G/U/I/D/E/ B/O/O/K

Commercial Gas Stove
RSB-320L / RSB-420L





INDEX

Components 2

Product installation 3

Prior to use 5

Gas leakage 6

How to use 7

Ignition check window 9

How to maintain 10

Measure when error 11

The proper way to use 12



Components

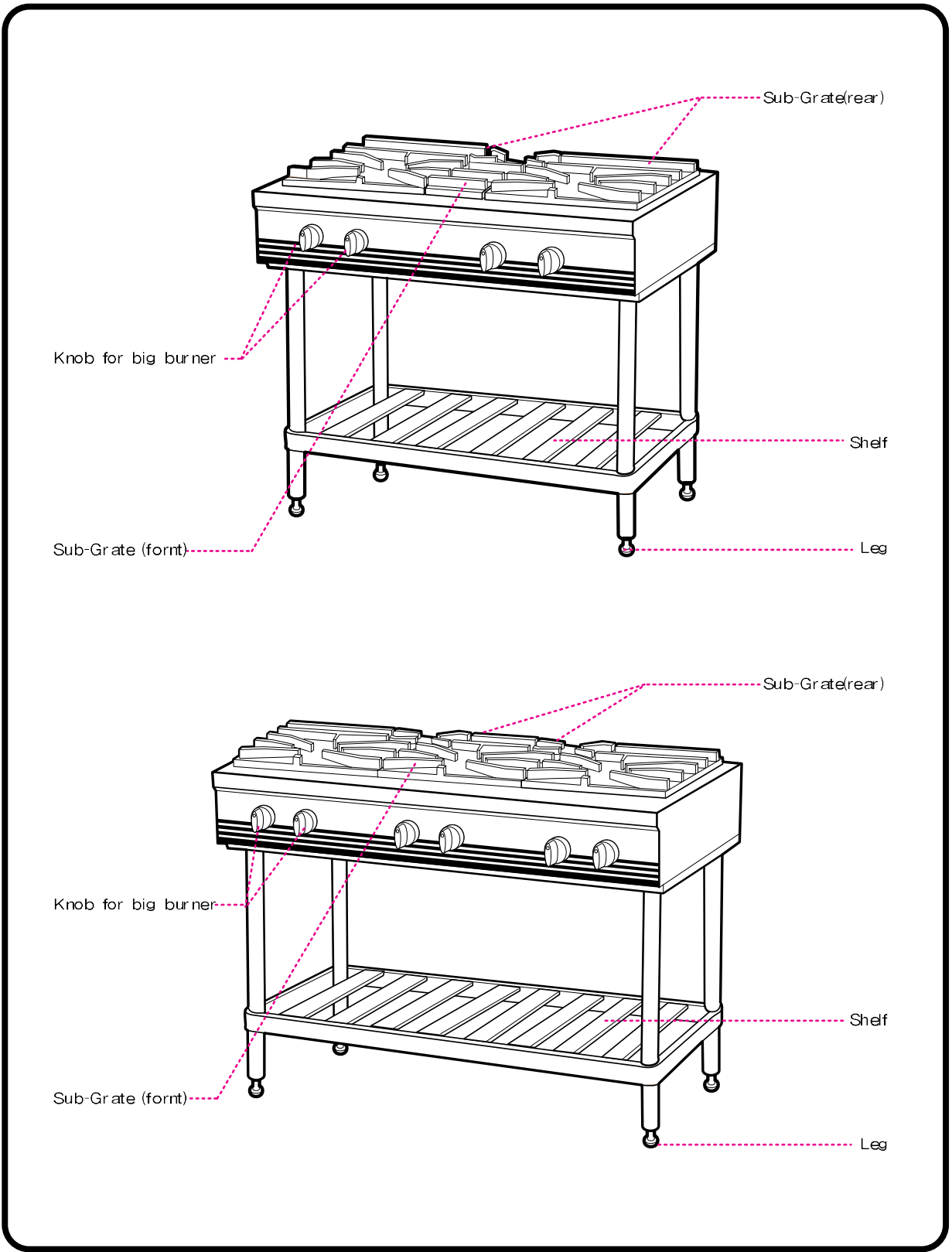

2

Product installation

■ Ventilate place

-During operation, make sure that both the air supply and gas exhaust system are working well.

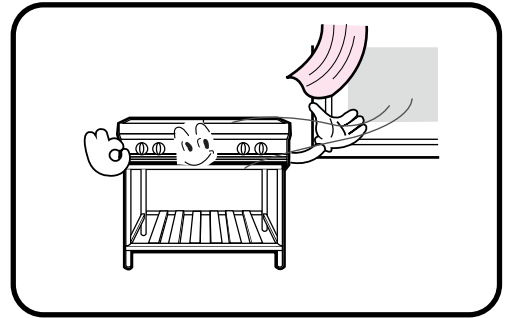

■ Flammable materials

-Never put flammables such as petroleum near the unit, which may cause a fire.

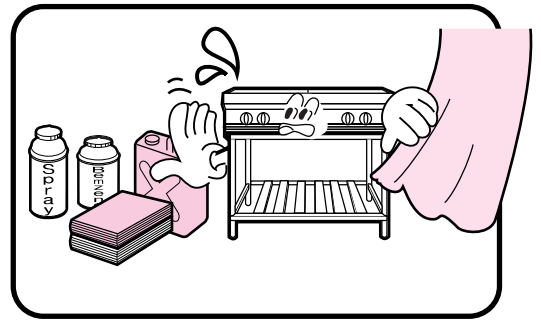

■ Location of the product installation

-Please install the unit on the place in stability and even ground.

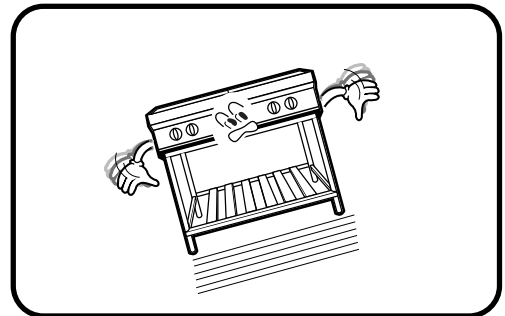

■ Recommend short piping

-We recommend you to install the gas pipe shortly.

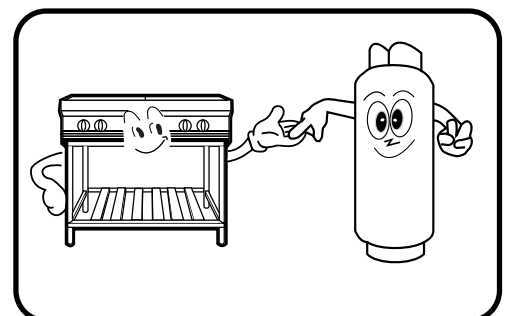

3

Product installation

■ Gas valve

-Install the intermediate valve near the unit.

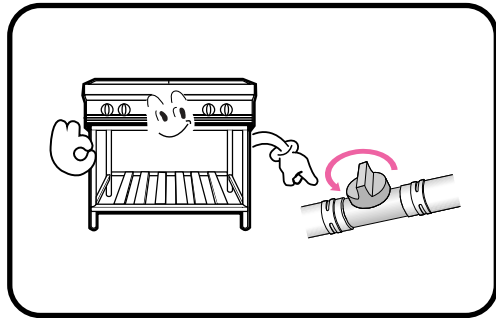

■ Avoid strong wind

-Strong wind may cause a sudden extinguishing and flame trouble.

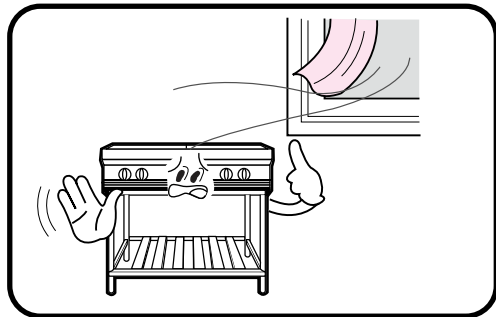

■ Keep the unit away from the wall

-Make sure to keep the unit away from the wall like side picture otherwise, install the insulator.

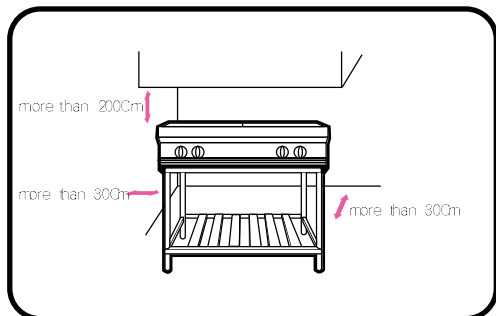

■ Gas connection

-Request a gas agency or its relevant company for gas connection.

-Fasten the gas pipe to fit with elbow.

-Never use rubber hose(φ 9.5mm).

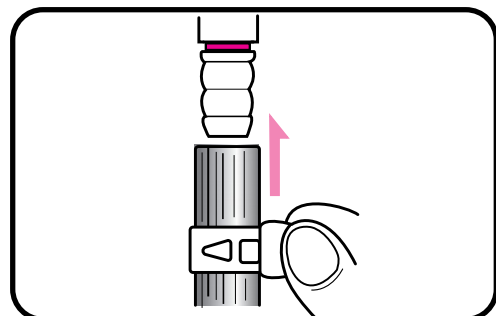



Prior to use

■ Gas type

-Must use the designated gas.

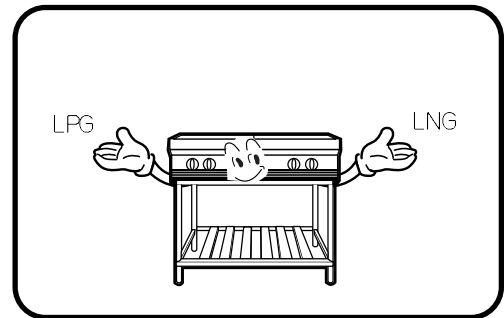

■ The knob position is 「off」

-Check the knob position before opening the gas valve

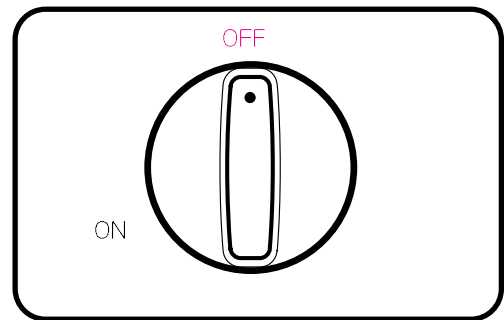

5

Gas leakage

■ Gas smell

-As fuel gas contains mercaptan, a gas leakage can be detected by its smell.

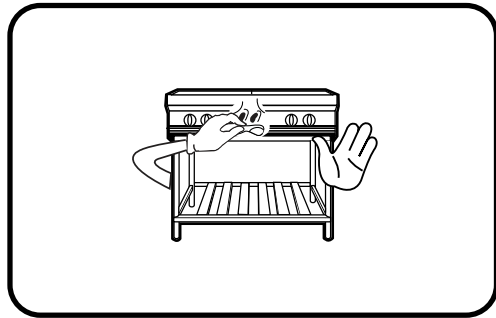

■ Precaution

-Ensure that the gas supply hose is not bent or being pressed exceedingly.

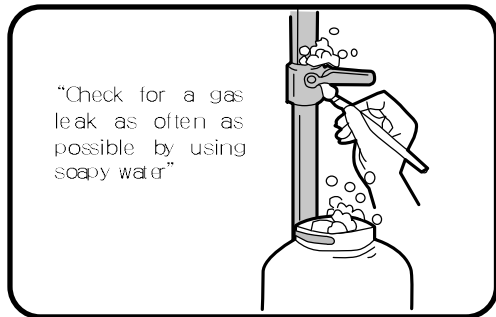

1 Take extra precaution not to do anything that may trigger an explosion.
(Do not touch a telephone and switches for a ventilation fan, etc)

2 Immediately close the valve on the gas supply hose and ventilate the room properly.

3 Call the service agency for help on ventilating the room properly.
(Use an outdoor telephone when you call for help.)

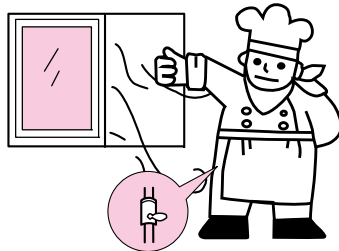
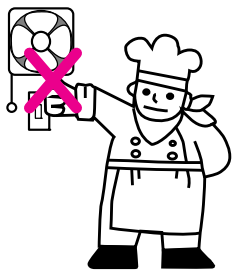



6

How to use

■ Open the gas valve

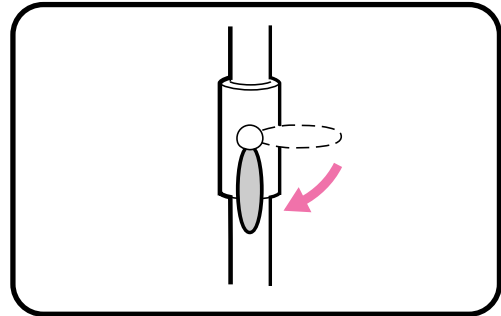

■ Ignition

- Press down slightly the knob and turn to “on” and check the flame
- In case of ignition failure immediately repeat a knob turning.

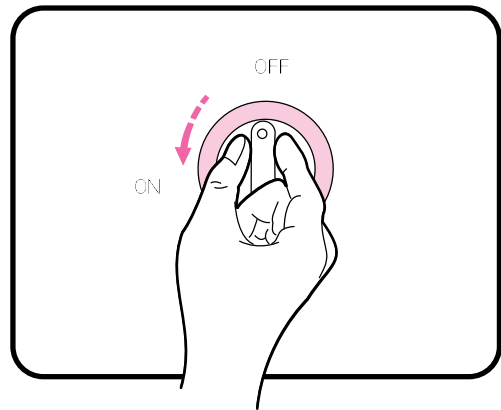

※ Caution

- If you do not press down the knob, it may cause a knob damage or ignition failure.
- When you ignite the gas stove for the first time the air filled in the gas pipe may cause ignition failure.

■ Air adjustment

- The burner already fixed to suit with proper air.

7

How to use

■ Flame control

-Turn the knob softly and completely to the "on" position.

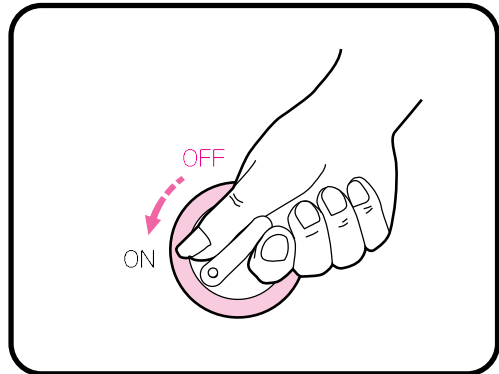

■ Extinguishment

-Turn the knob to the "off" position completely.

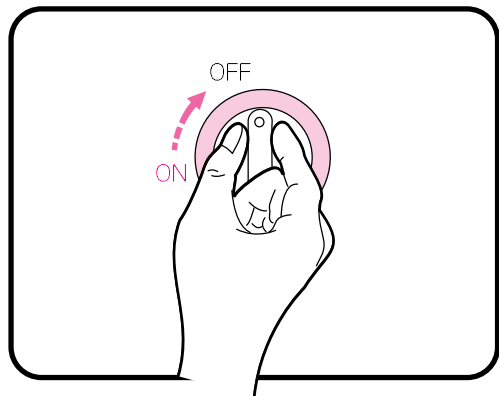

■ Close the intermediate valve

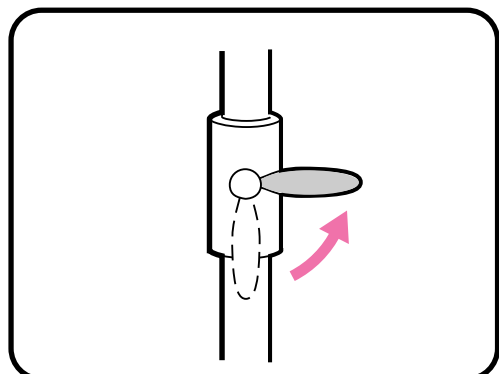



Cautions during use

■ Flammable materials

- Do not put on the flammable material like petrol, benzene it might be caused a fires

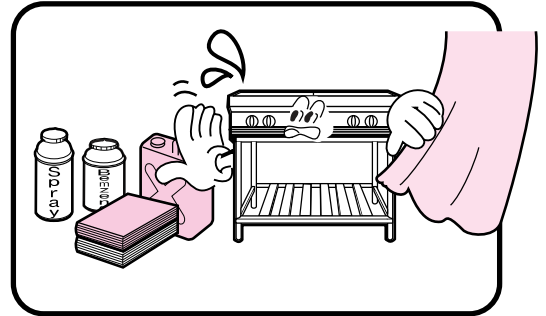

■ Another cooking material

- Do not use a another cooking plate which block the flame
- It may cause a abnormal combustion, over-heating.

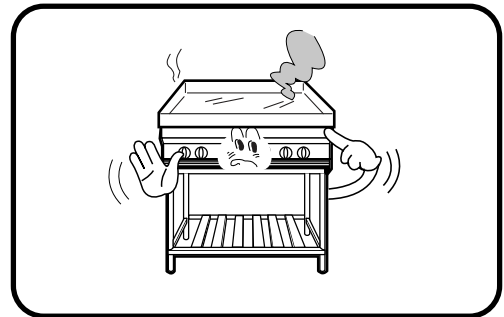

■ Frequently ventilate the air

- Frequently ventilate air in the kitchen.

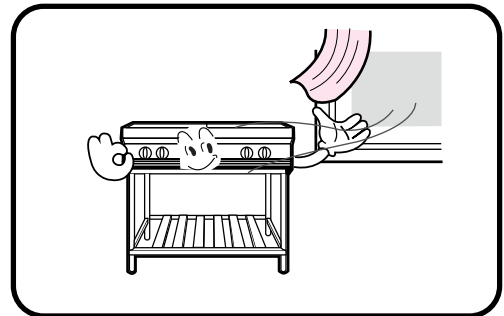

■ Do not use except for cooking

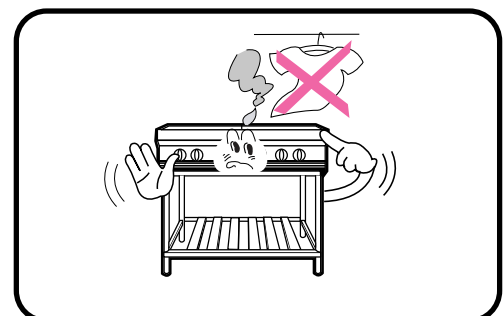

9

How to maintain

■ Unit outside, inside and Grate, Soup tray

-Clean the unit using warm soap water and then polish using dry cloth

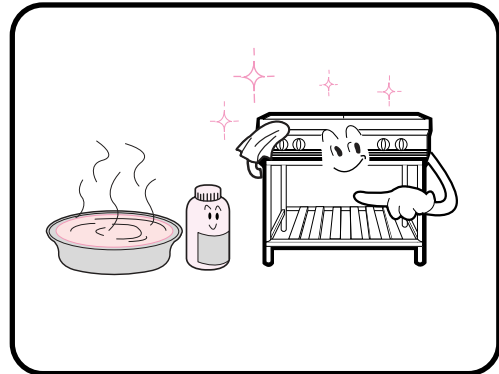

■ Burner

-From time to time. The burner need to be cleaned by soft brush a gimlet for flame hole.

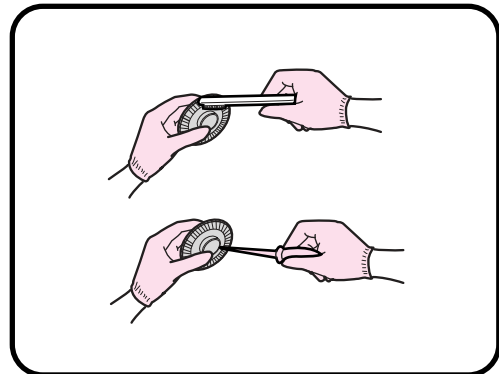

■ Sparker

-Clean the dirt around sparker using dry cloth slowly.
And, Be careful of electric shock when the flame knob is turning.

※ When cleaning time, should be careful not to overgab between sparker and lead wire.

10

Trouble shooting



If error occurs during use, stop using and shut the middle valve and ventilate air.

Error	Cause	Measures
No ignition when a gas is available	Ignition sparker trouble.	Clean the sparker and around sparker.
Noise occur during ignition and using.	Back - fire.	At first extinguish the unit and ignite again.
Gas odor.	-Mal-connection. -Mal-combustion.	-Fasten. Replace -Close the gas valve and call sales agency.
Black dirt.	-Burner hole block -Air shortage.	Remove the block material.

11

Exterior specifications

RSB-320L

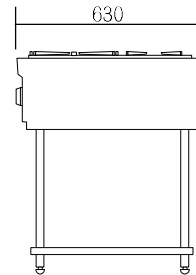
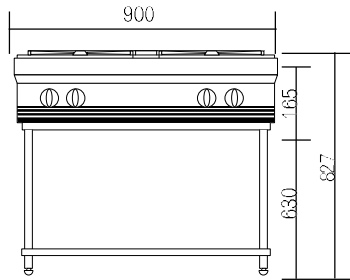

RSB-420L

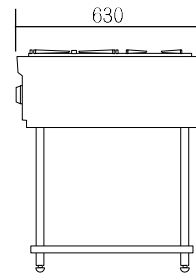
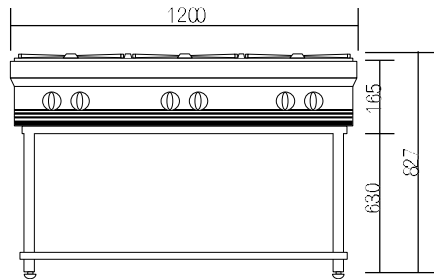

Description		Gas Range			
Model		RSB-320L		RSB-420L	
Size	Width	900		1200	
	Length	630		630	
	Height	827	260	827	260
Weight		73	71	90	87
Gas connection		25A(1")			
LPGas	B'g	35.500		53.000	
B.T.U		79.400		119.000	



MEMO



MEMO

Rinnai

ver. 050214

